

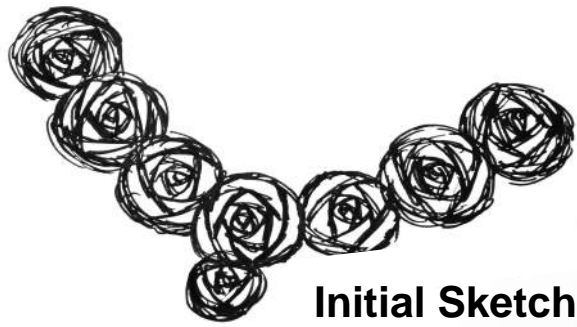

ACM SIGGRAPH
EDUCATION COMMITTEE

**2014 FACULTY SUBMITTED
STUDENT WORK EXHIBIT**



Initial Sketch

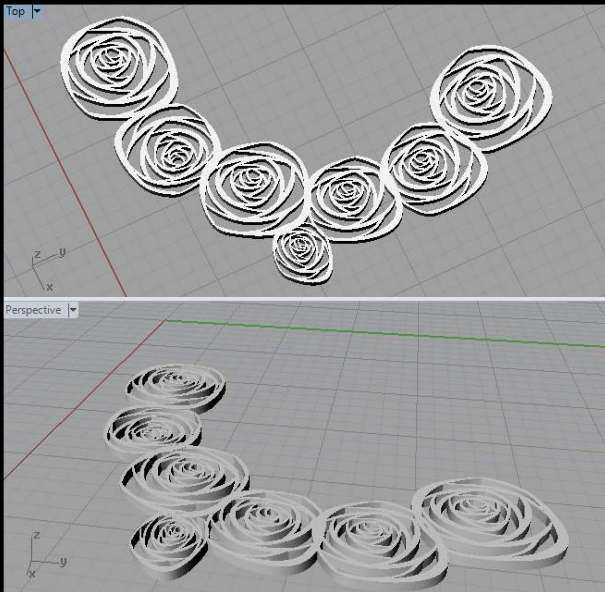

Rhino model



The finished product

**A
customizable
necklace**



Student name: Bella Carriker
School name: Lakeside School
Program/department: Computer Science
Faculty name: Dr. Lauren Bricker
Project: Gifts and games

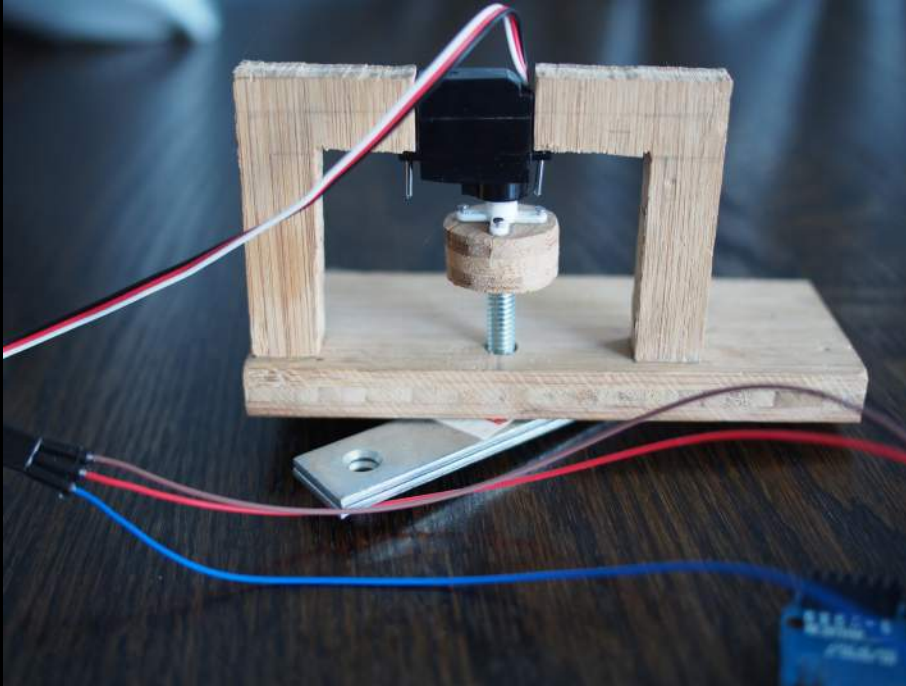

Student name: Karsten Roberts
School name: Lakeside School
Program/department: Independent Study
Faculty name: Lauren Bricker
Project: Timed Camera



Student name: George Bason

School name: Living Arts College

Program/department: Animation and Game Design

Faculty name: Kwame Hawkins

Project: Cinematic Character Concept Art

PS3

PlayStation Network



RATING PENDING
RP
CONTENT RATED BY
ESRB
Online Interactions
Not Rated by the ESRB



KONAMI

Student name: Von Ruckel

School name: Living Arts College

Program/department: Animation And Game Design

Faculty name: Kwame Hawkins

Project: Cinematic Character Poster

ACMSIGGRAPH
EDUCATION COMMITTEE



Side
(Bottom)



Top



Side
(Head)



Back



Front



Three-Quarter

Kimberly Marshburn
Prop Model & Texture -Western Concert Flute
GM403 Game Design Strategies

Student name: Kimberly Marshburn

School name: Living Arts College

Program/department: Animation and Game Design

Faculty name: Benjamin R Parks

Project: Prop Model and Texturing



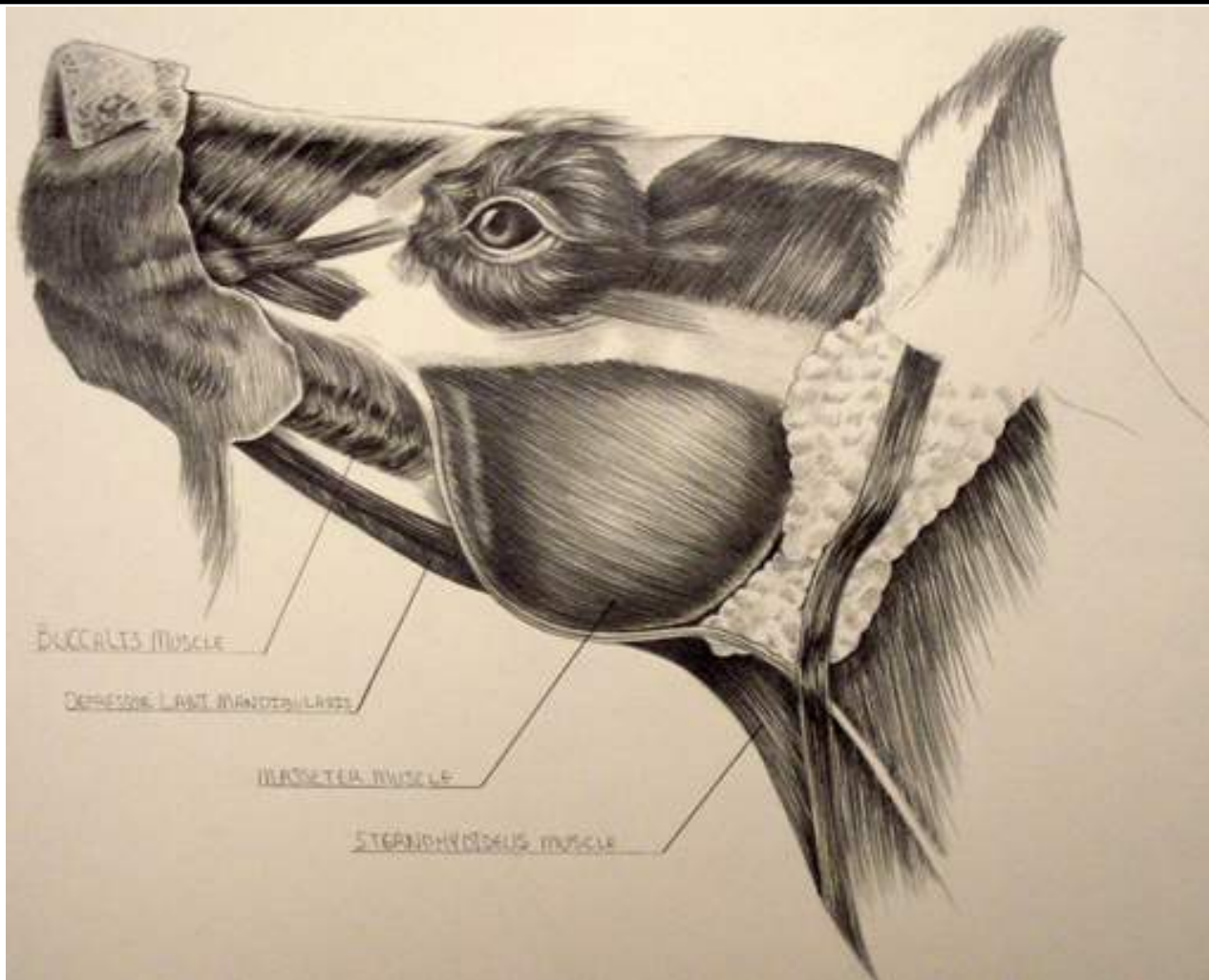

Student name: Beth Ann Seiberling

School name: Living Arts College

Program/department: Animation and Game Design

Faculty name: Rich Ponte

Project: Muscle Study

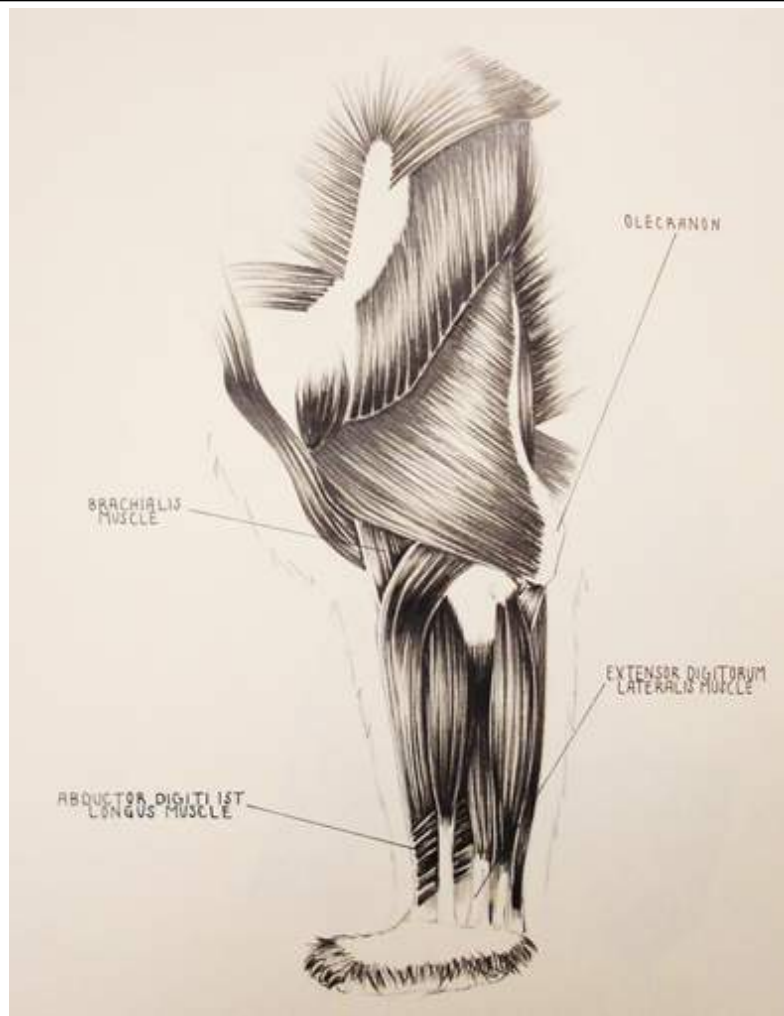

Student name: Ambar Catalan

School name: Living Arts College

Program/department: Animation and Game Design

Faculty name: Rich Ponte

Project: Muscle Study



HEDGEHOG



AFRICAN GRAY PARROT



SEA TURTLE

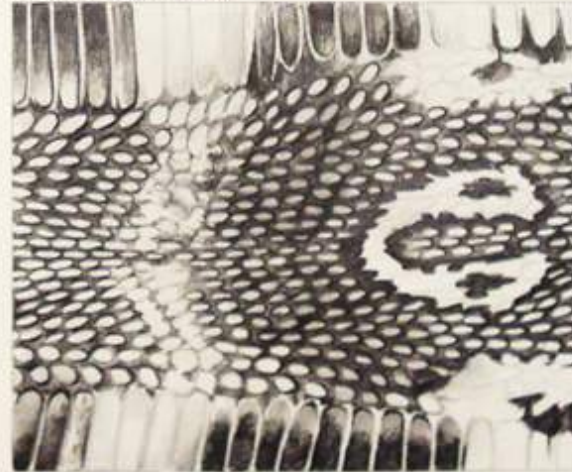

COBRA

Student name: Ambar Catalan

School name: Living Arts College

Program/department: Animation and Game Design

Faculty name: Rich Ponte

Project: Texture Study

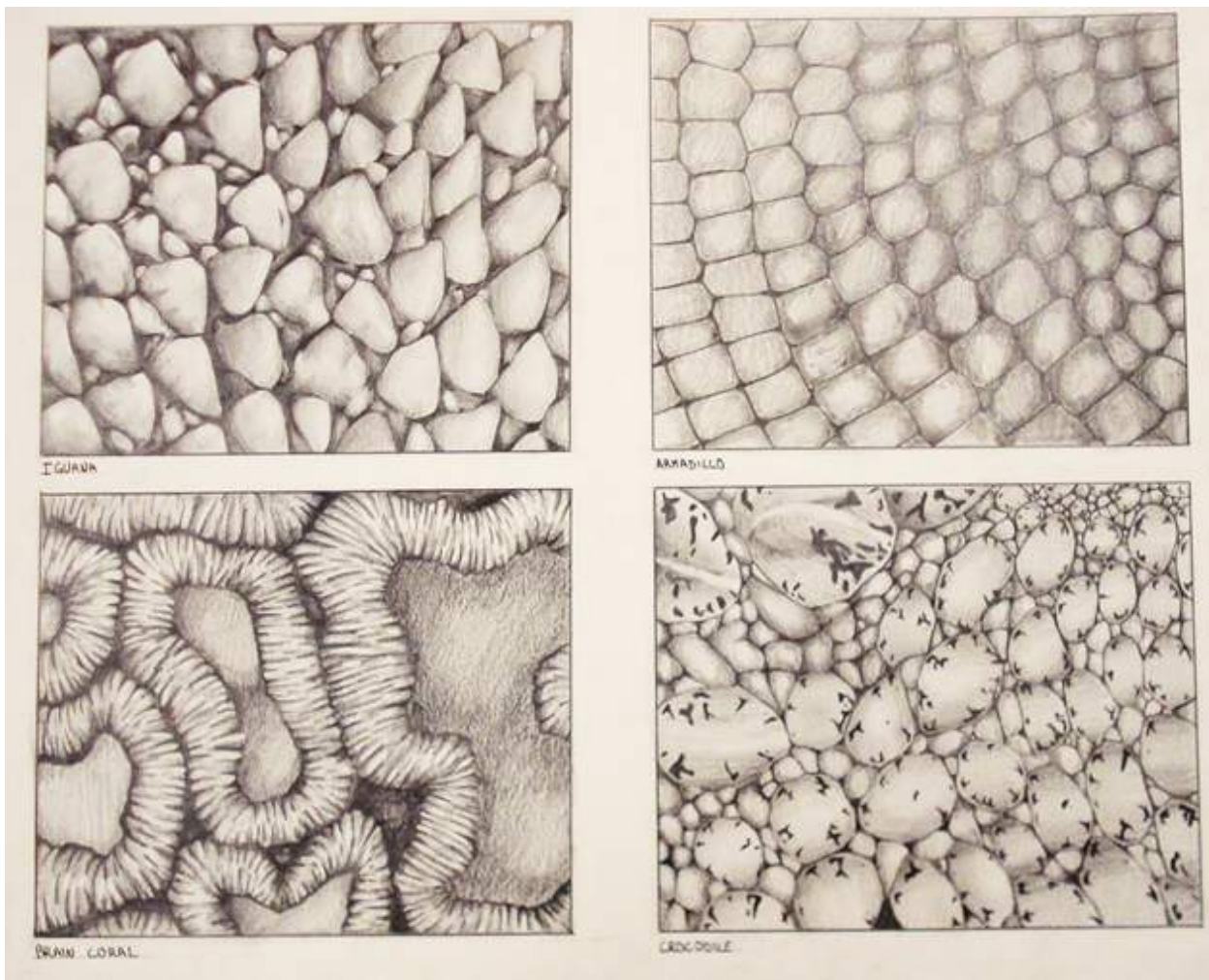

Student name: Andrew Favaron

School name: Living Arts College

Program/department: Animation and Game Design

Faculty name: Rich Ponte

Project: Texture Study

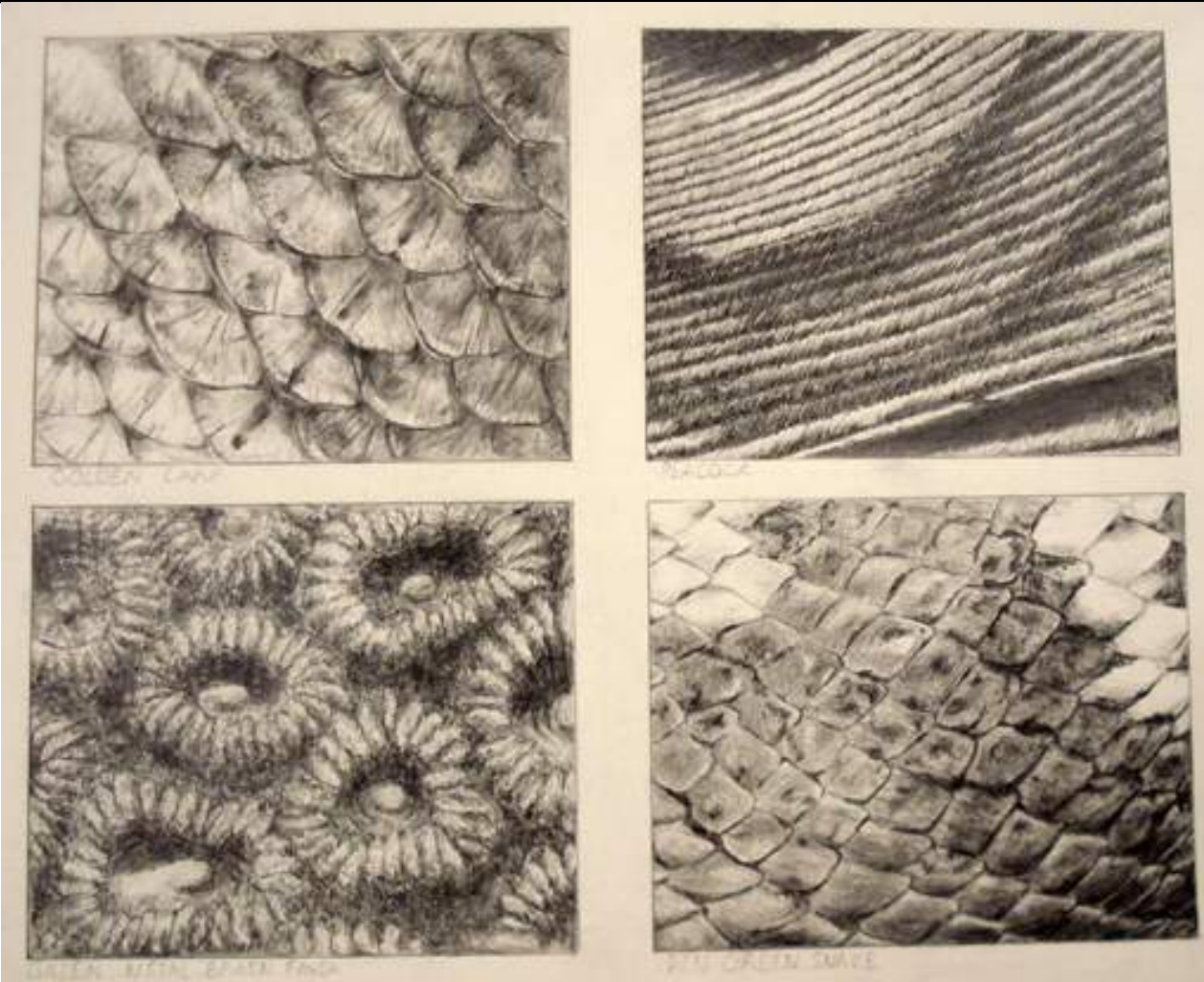

Student name: Cindy Nguyen

School name: Living Arts College

Program/department: Animation and Game Design

Faculty name: Rich Ponte

Project: Texture Study



Student name: Katie Moore

School name: Living Arts College

Program/department: Animation and Game Design

Faculty name: Kwame Hawkins

Project: Cinematic Character Turnaround



Student name: Von Ruckel

School name: Living Arts College

Program/department: Animation and Game Design

Faculty name: Kwame Hawkins

Project: Cinematic Character Turnaround



Student name: Derrick Nsibuka

School name: Living Arts College

Program/department: Animation and Game Design

Faculty name: Kwame Hawkins

Project: Cinematic Character Turnaround





Student name: Jacob Sutton

School name: Living Arts College

Program/department: Animation and Game Design

Faculty name: Kwame Hawkins

Project: Game Level

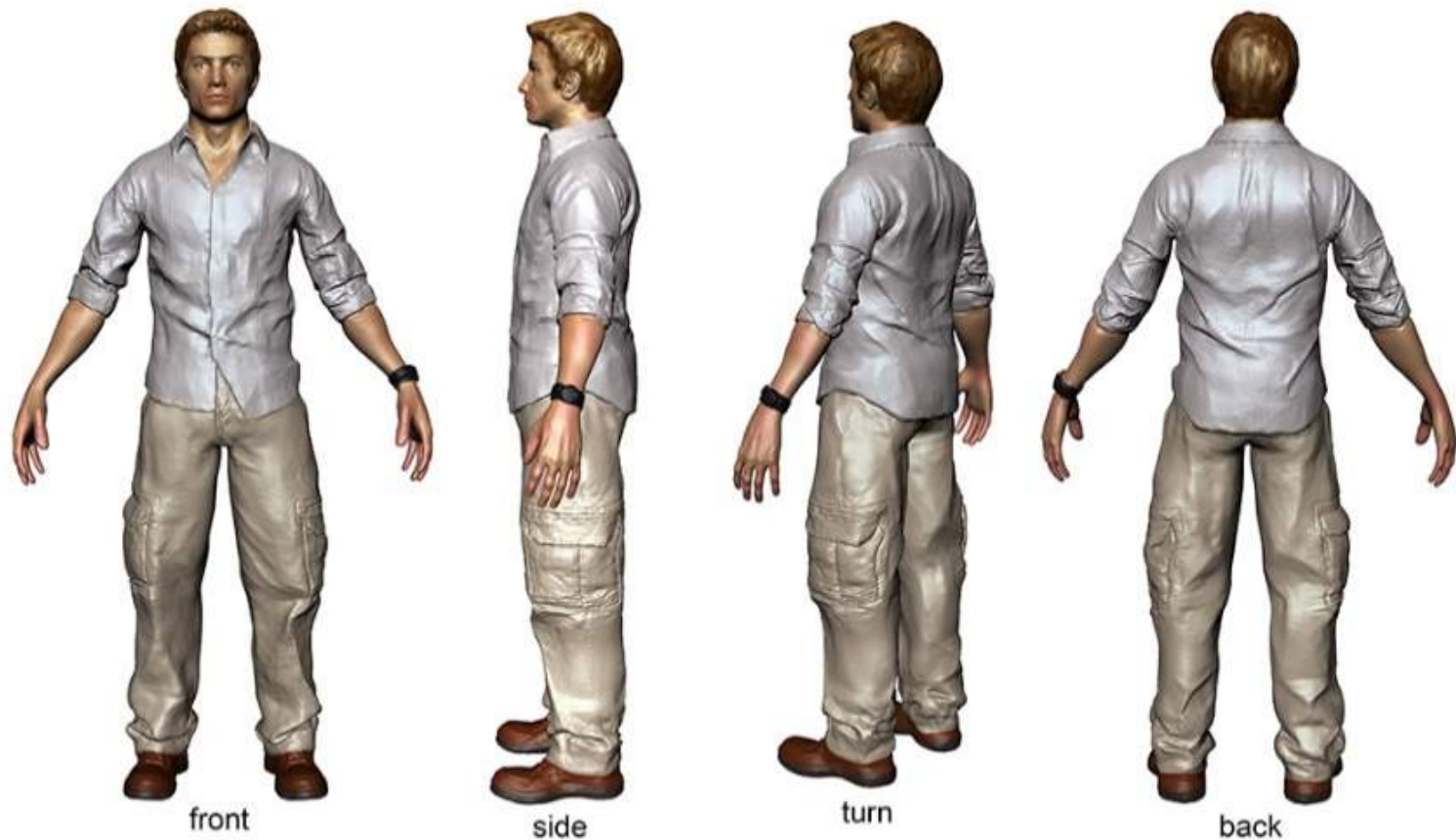

George Bason

Student name: George Bason

School name: Living Arts College

Program/department: Animation and Game Design

Faculty name: Rich Ponte

Project: Human Character Sculpt from Base Mesh

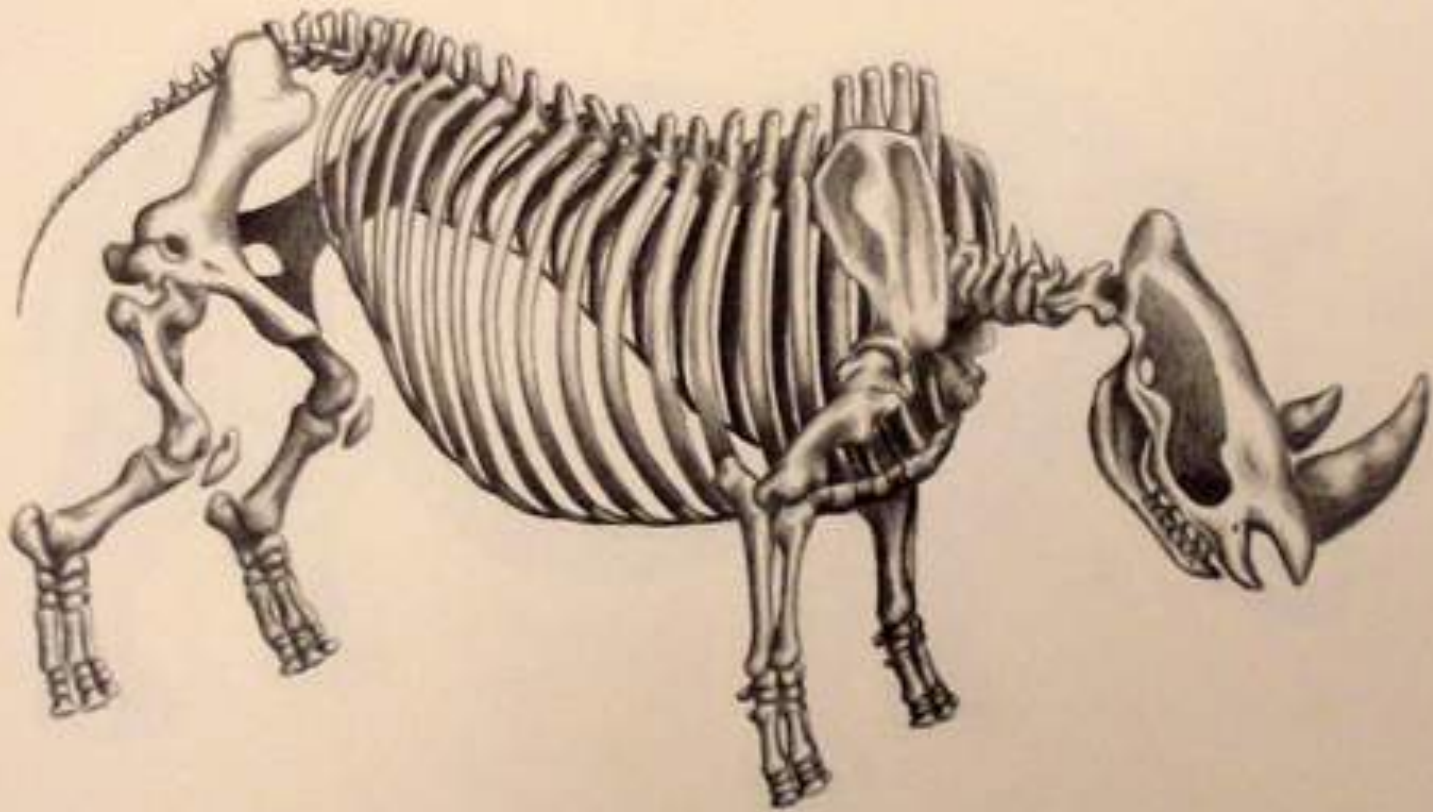

Student name: Beth Ann Seiberling

School name: Living Arts College

Program/department: Animation and Game Design

Faculty name: Rich Ponte

Project: Animal Anatomy



Student name: Von Ruckel

School name: Living Arts College

Program/department: Animation and Game Design

Faculty name: Rich Ponte

Project: Cinematic Character Concept Art



Student name: Derrick Nsibuka

School name: Living Arts College

Program/department: Animation and Game Design

Faculty name: Rich Ponte

Project: Cinematic Character Concept Art



Student name: Bryon Redfield

School name: Living Arts College

Program/department: Animation and Game Design

Faculty name: Rich Ponte

Project: Concept Art



Student name: Jacob Sutton, Christina Hannah, Kimberly Marshburn,
Bryant Sapp, Caleb Heidelmeier, Marshawn Howard

School name: Living Arts College

Program/department: Animation and Game Design

Faculty name: Ben Forman

Project: Animated Group Project Short





Student name: Maryam Navaei

School name: Living Arts College

Program/department: Animation and Game Design

Faculty name: Kwame Hawkins

Project: 2.5D Shooter



Student name: Von Ruckel

School name: Living Arts College

Program/department: Animation and Game Design

Faculty name: Rich Ponte

Project: Environment Model



Student name: Katie Moore

School name: Living Arts College

Program/department: Animation and Game Design

Faculty name: Matthew Heimbecker

Project: Prop Model



Student name: Derrick Nsibuka

School name: Living Arts College

Program/department: Animation and Game Design

Faculty name: Rich Ponte

Project: Prop Model



Student name: Jacob Sutton, Kimberly Marshburn, Bryant Sapp, Marshawn Howard

School name: Living Arts College

Program/department: Animation and Game Design

Faculty name: Kwame Hawkins

Project: Group Game Project



<http://youtu.be/ngqcPTn5ZgE>

Student name: Von Ruckel

School name: Living Arts College

Program/department: Animation and Game Design

Faculty name: Kwame Hawkins

Project: Human Bust Sculpt



<http://youtu.be/OYZaZmFU7hI>

Student name: Derrick Nsibuka

School name: Living Arts College

Program/department: Animation and Game Design

Faculty name: Kwame Hawkins

Project: Human Bust Sculpt



Student name: George Bason

School name: Living Arts College

Program/department: Animation and Game Design

Faculty name: Benjamin R Parks

Project: Human Bust Sculpt





Animation: <https://vimeo.com/94023644>

Documentary: <https://vimeo.com/91361066>

Student name: Tynesha Foreman, Sarah Bushin, Isaac Ewart, Natasha Nayo, Shari Pryce, Nicky St. Onge, Tara Saldajeno, LeJea Williams, Lisa Deng, Dana Zhang, Jordan Jackson, Eunbi Choi, Jihye Jung, Sydney Citrone, Marc De Leon

School name: Maryland Institute College of Art

Program/department: Animation Department

Faculty name: Laurence Arcadias & Robin Corbet (Fermi scientist)

Project: Animatic Fermi





<https://vimeo.com/95568549>

Student name: Classes of 2013

School name: Middle Tennessee State University

Program/department: Electronic Media Communication

Faculty name: Kevin McNulty

Project: Brundle Model, Robots & Machines, Still Life, Lip Sync, Animated Short Film



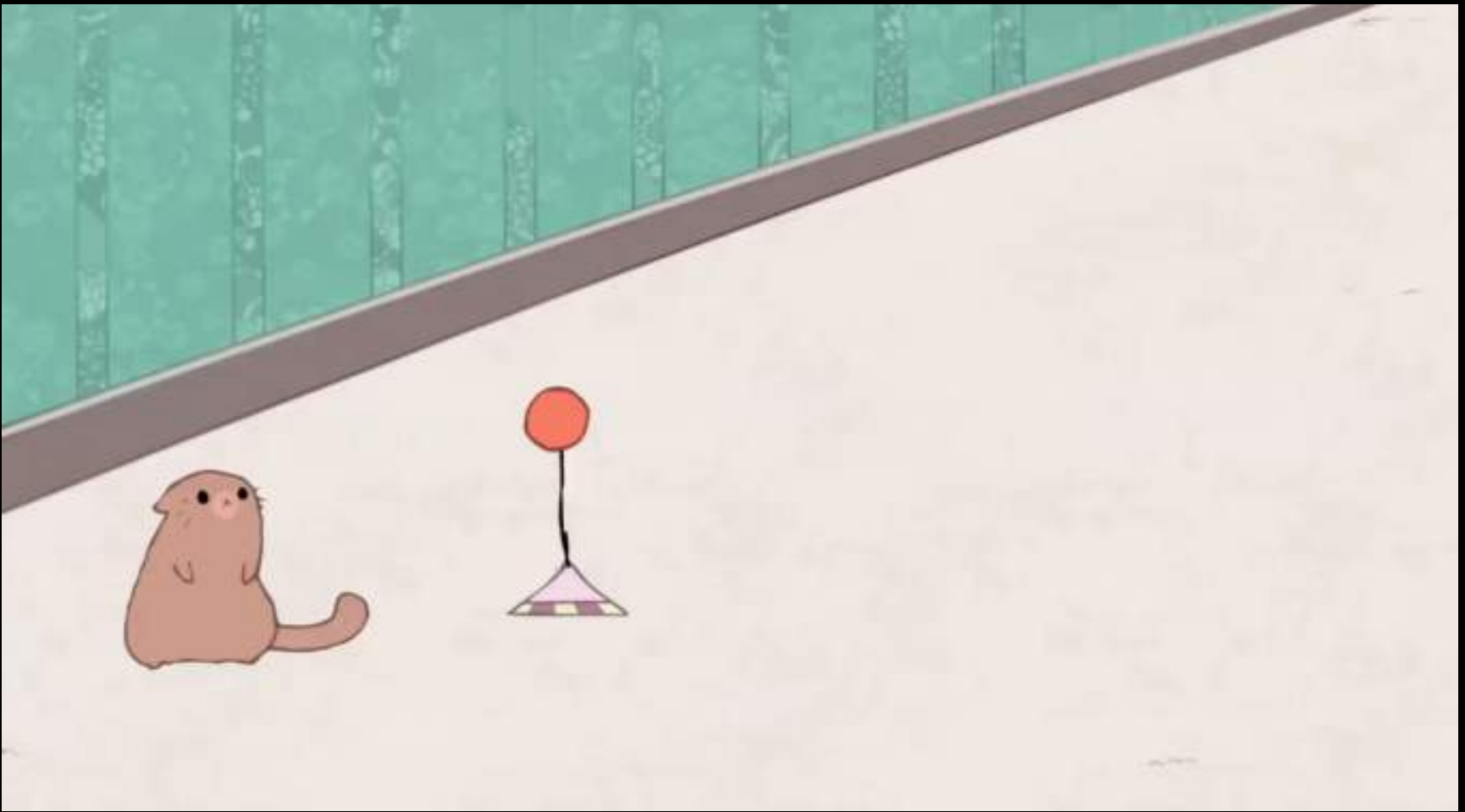

<https://vimeo.com/95568551>

Student name: Classes of 2013

School name: Middle Tennessee State University

Program/department: Electronic Media Communication

Faculty name: Kevin McNulty

Project: Bouncing Ball, Flipbook, Final Group Animation





Facsimile of Hiroshige's *Kinryuzan Temple, Asakusa* (1856) created by Nahin Shah

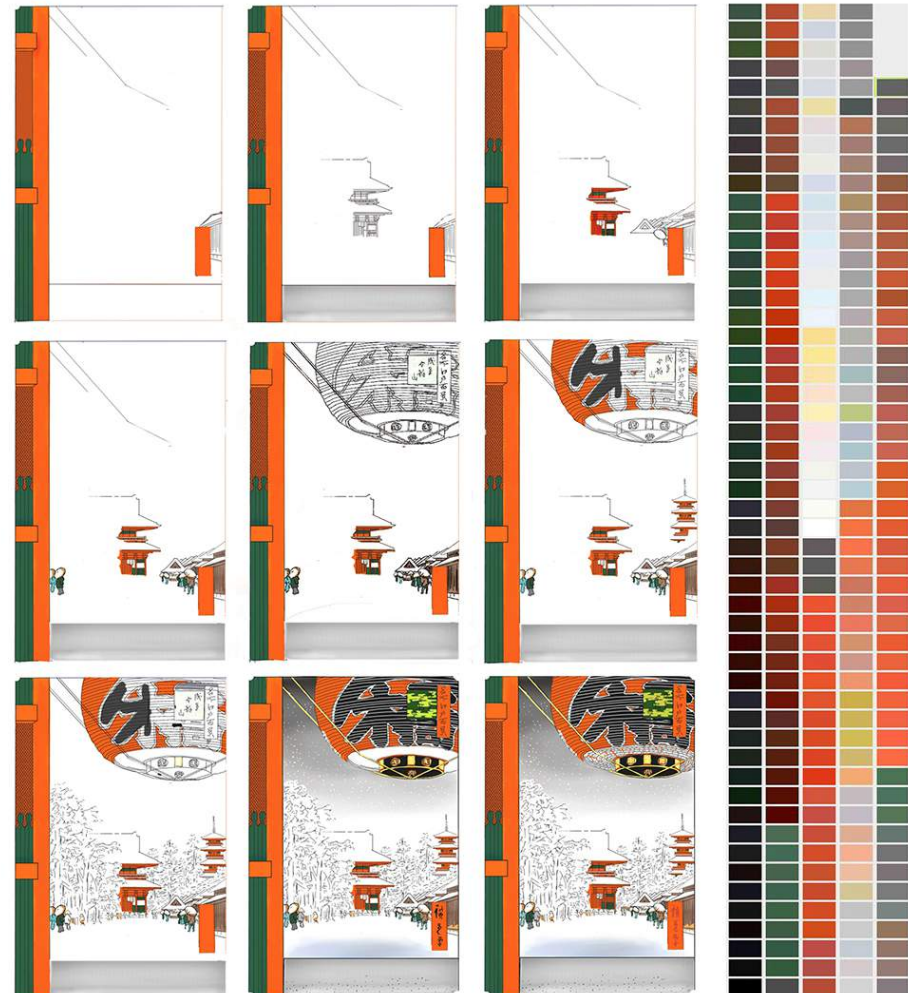

Student name: Nahin Shah

School name: New Jersey Institute of Technology

Program/department: School of Art + Design

Faculty name: Glenn Goldman

Project: Painting Facsimile and Study

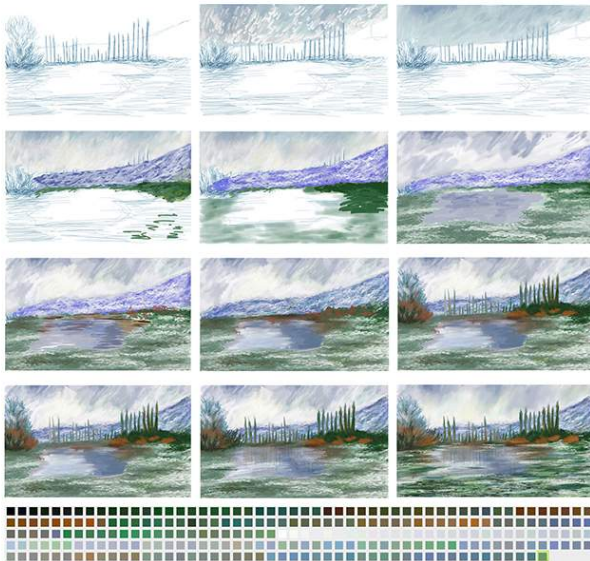

Facsimile of Claude Monet's *The Pier in Vevey, 1881* by Taylor Kline

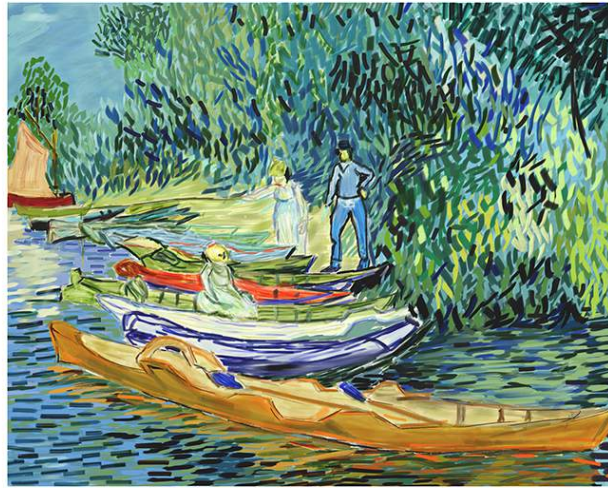

Facsimile of Vincent Van Gogh's *Bank of the Oise at Auvers* (1890) by Dakshita V. Supawala

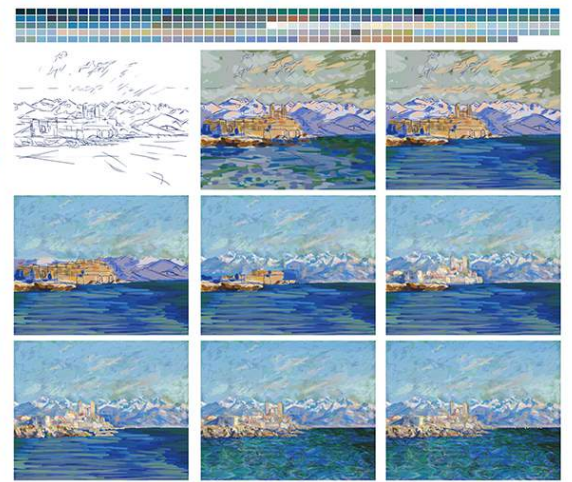

Facsimile of Claude Monet's *The Fort of Antibes* (1888) by Kimberly Hastings

Student name: Taylor Kline, Dakshita Supawala, Kim Hastings

School name: New Jersey Institute of Technology

Program/department: School of Art + Design

Faculty name: Glenn Goldman

Project: Painting Facsimile and Study





Facsimile of Edgar Degas's *Two Ballet Dancers in a Dressing Room* (1880) by Troy Benjamin

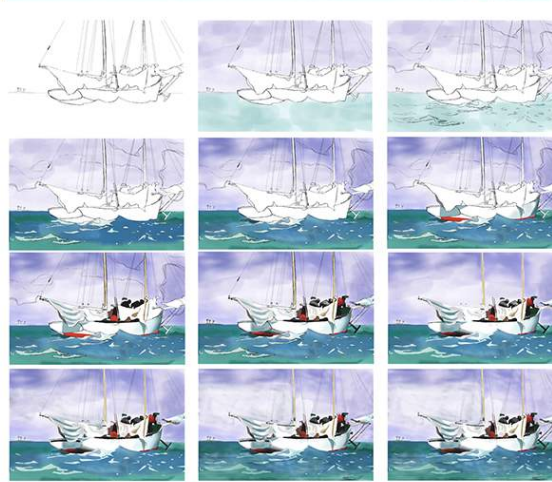

Facsimile of Winslow Homer's *Key West, Hauling Anchor* (1903) by Henry Drago

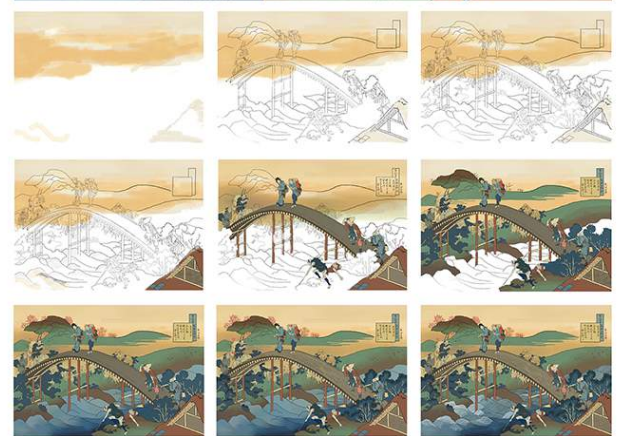

Facsimile of Katsushika Hokusai's *People Crossing Arched Bridge* (1835-36) by Pamela Jablonski

Student name: Troy Benjamin, Henry Drago, Pamela Jablonski

School name: New Jersey Institute of Technology

Program/department: School of Art + Design

Faculty name: Glenn Goldman and Taro Narahara

Project: Painting Facsimile and Study



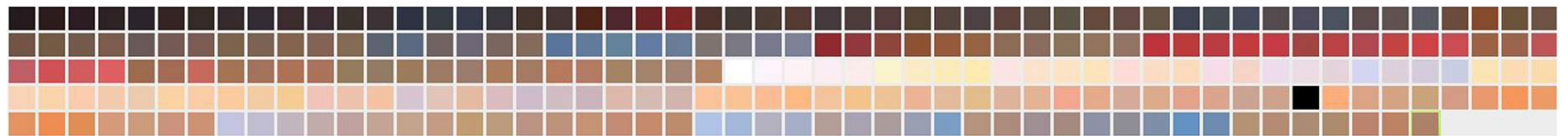

Fascimile of Paul Cezanne's *Man with a Blue Cap* (1866) by Nathaniel Soto

Student name: Nathaniel Soto

School name: New Jersey Institute of Technology

Program/department: School of Art + Design

Faculty name: Glenn Goldman

Project: Painting Facsimile and Study



Inheritance: Clean
Modifier: None

Inheritance: Instance
Modifier: Push/ Tessellate

Inheritance: Reference
Modifier: Push/ Tessellate/ Melt

Inheritance: Copy
Modifier: Lattice

Torus Knot/Ring Wave boolean

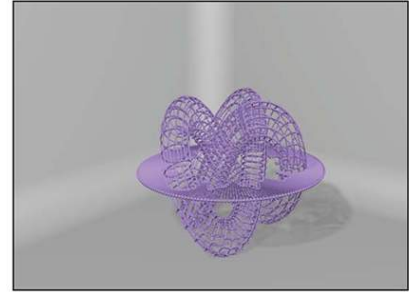
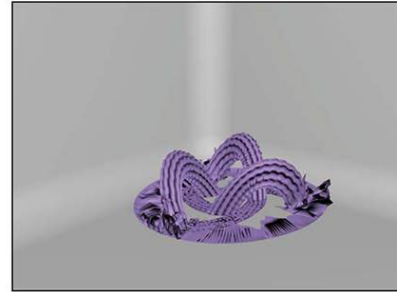
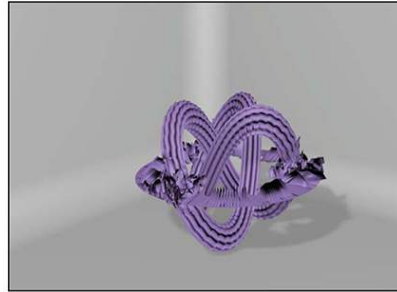
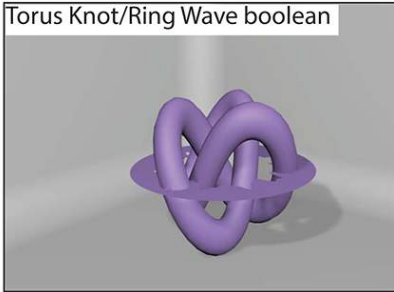

Capsule/Hose boolean

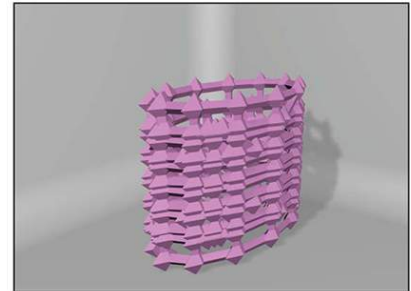
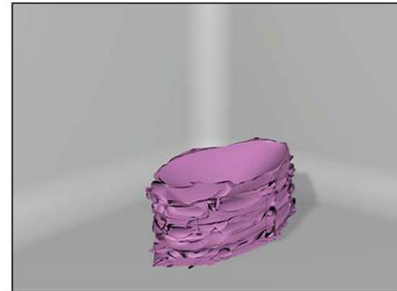
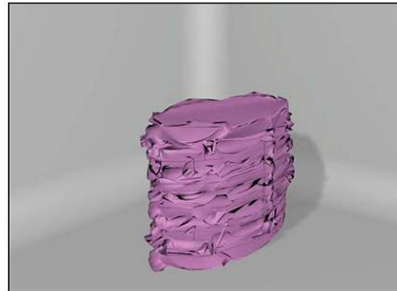
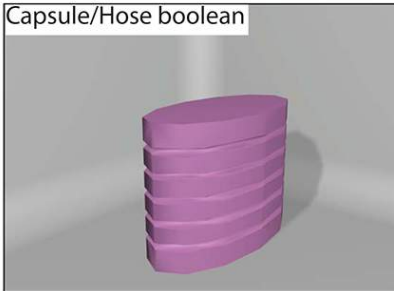

Spindle/ChamferCyl boolean

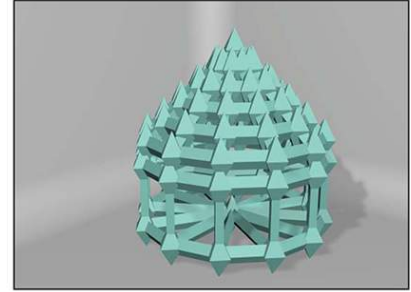
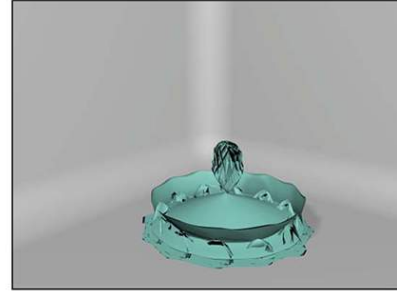
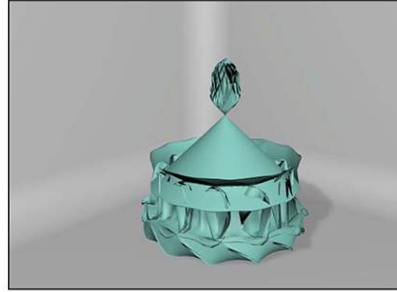
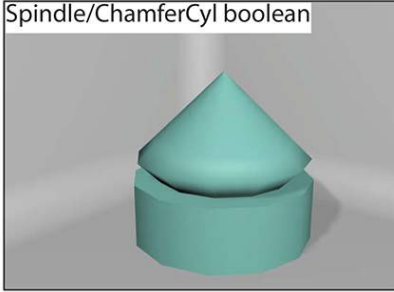

Morphology Matrices: Compound Objects

Student name: Niti Dattani

School name: New Jersey Institute of Technology

Program/department: School of Art + Design

Faculty name: Andrew Mailloux

Project: Digital Communication/3D Modeling/Chess Set Morphology



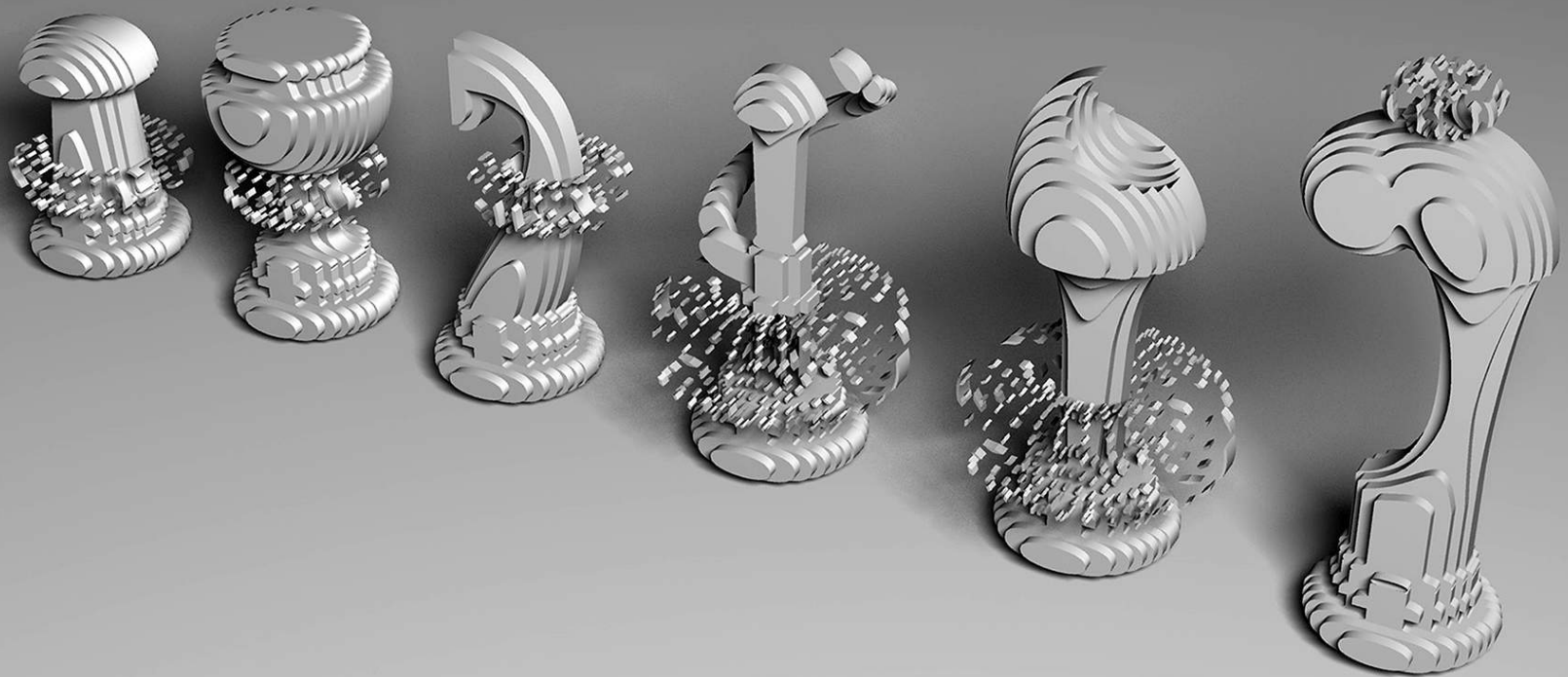

Student name: Malorie Pangilinan

School name: New Jersey Institute of Technology

Program/department: School of Art + Design

Faculty name: Augustus Wendell

Project: Digital Communication/3D Modeling/Chess Set



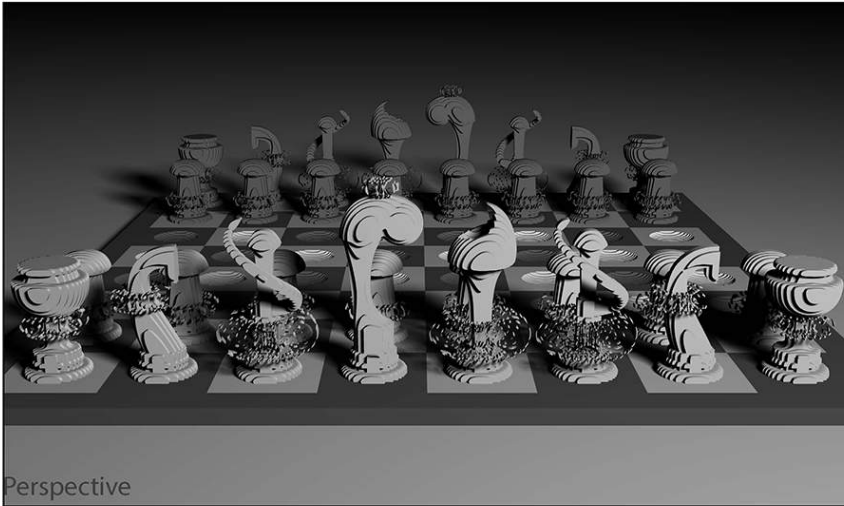

Perspective

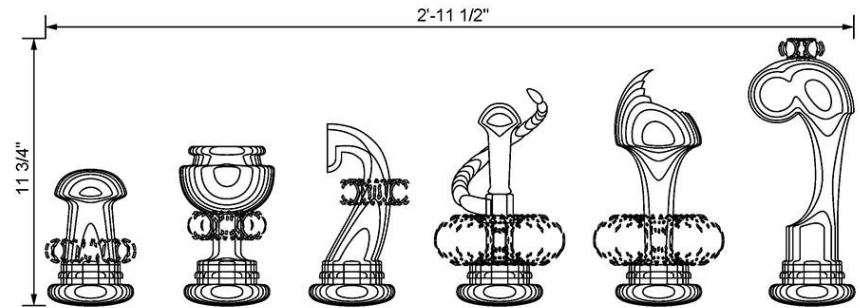

Height Comparison

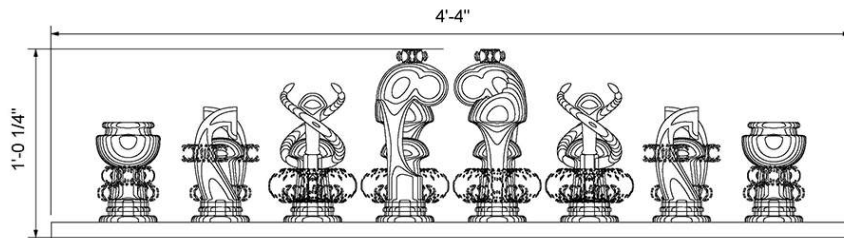

Front

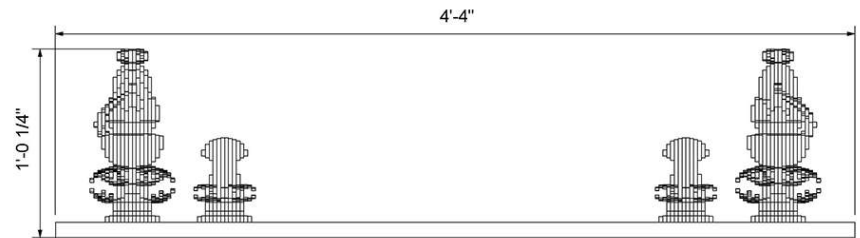

Side

Student name: Malorie Pangilinan

School name: New Jersey Institute of Technology

Program/department: School of Art + Design

Faculty name: Augustus Wendell

Project: Digital Communication/3D Modeling/Chess Set



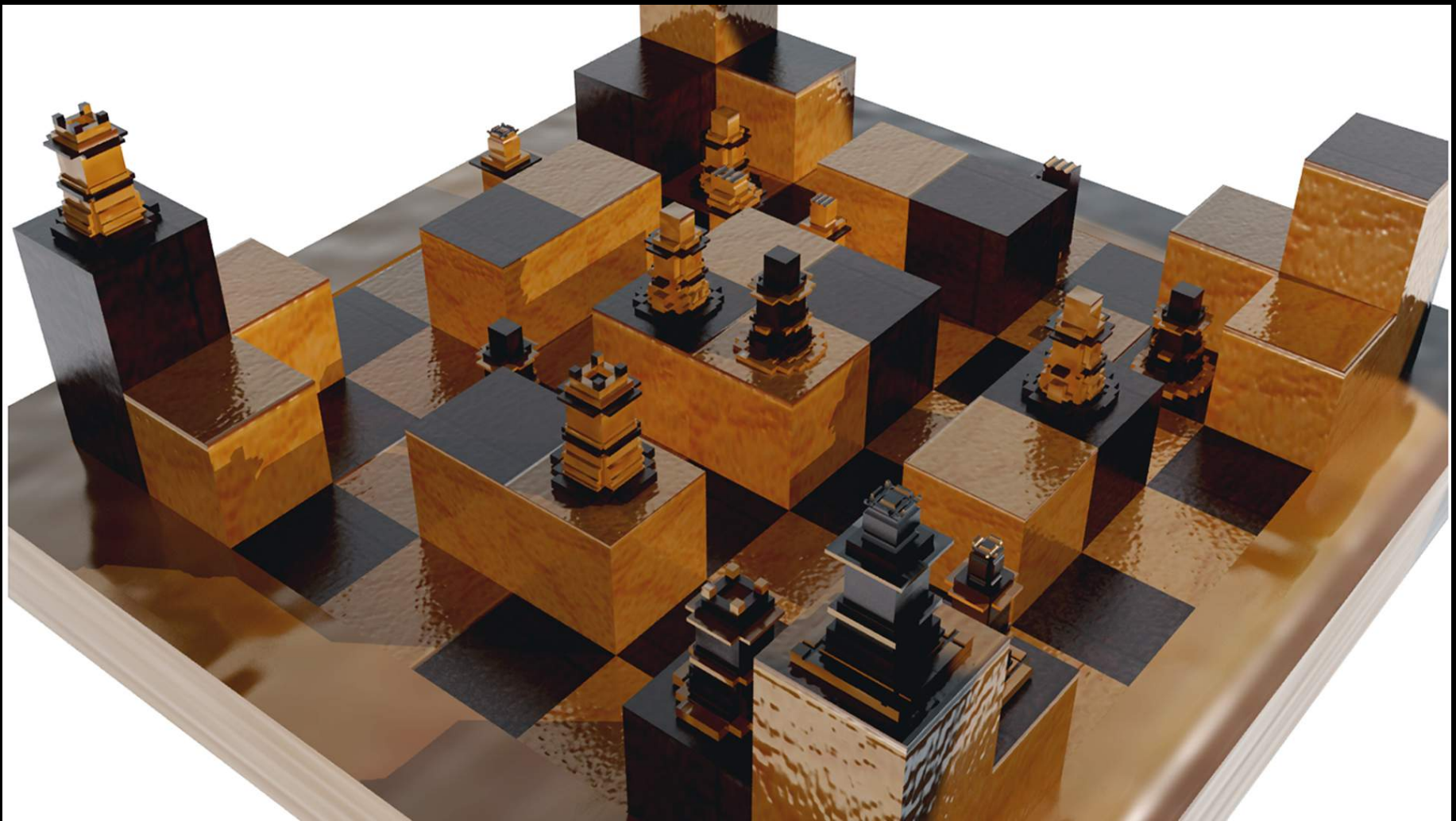

Student name: Amar Sohan

School name: New Jersey Institute of Technology

Program/department: School of Art + Design

Faculty name: Brent Klokis

Project: Digital Communication/3D Modeling/Chess Set



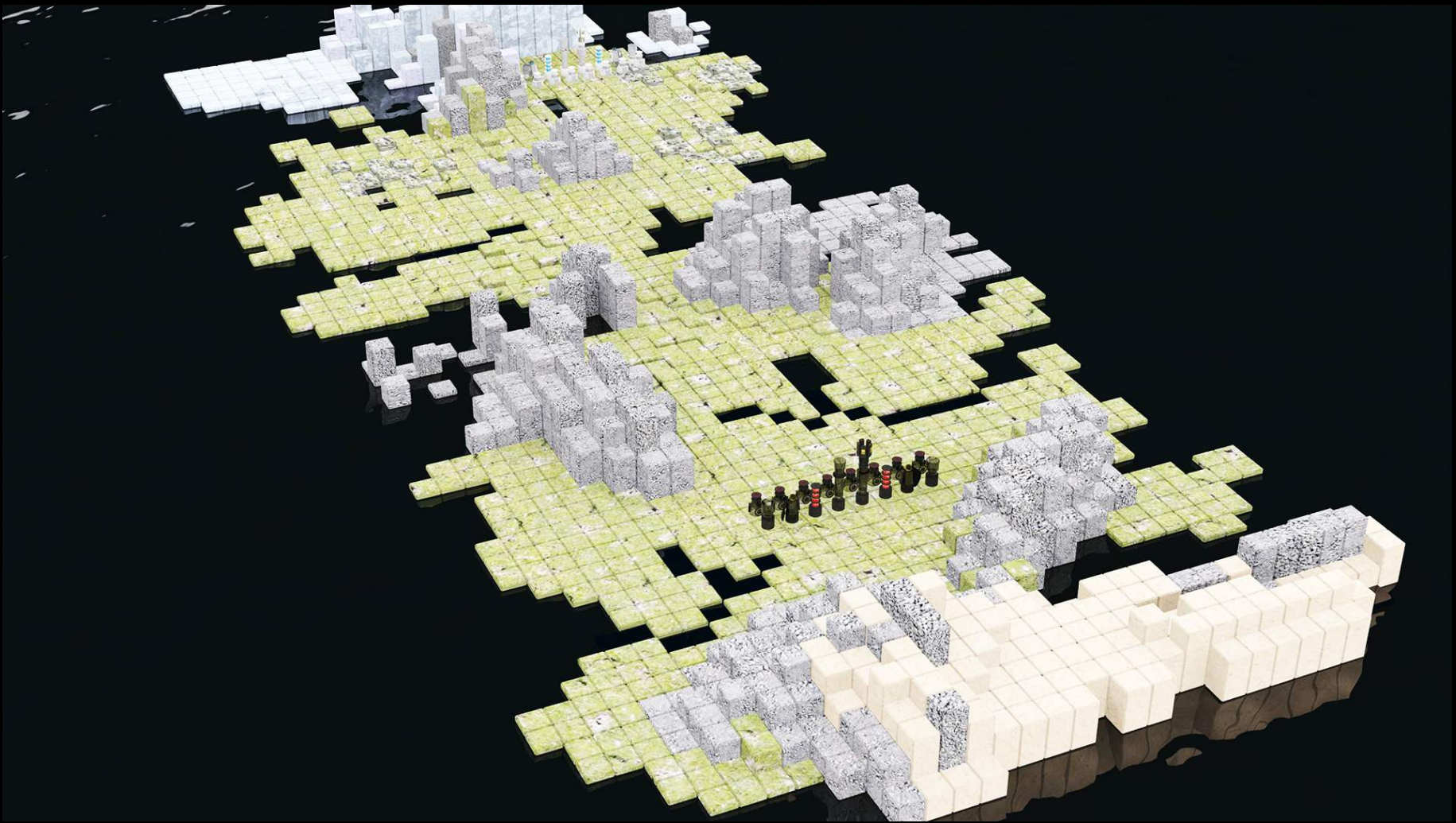

Student name: Robert Lockett

School name: New Jersey Institute of Technology

Program/department: School of Art + Design

Faculty name: Andrew Mailloux

Project: Digital Communication/3D Modeling/Chess Set



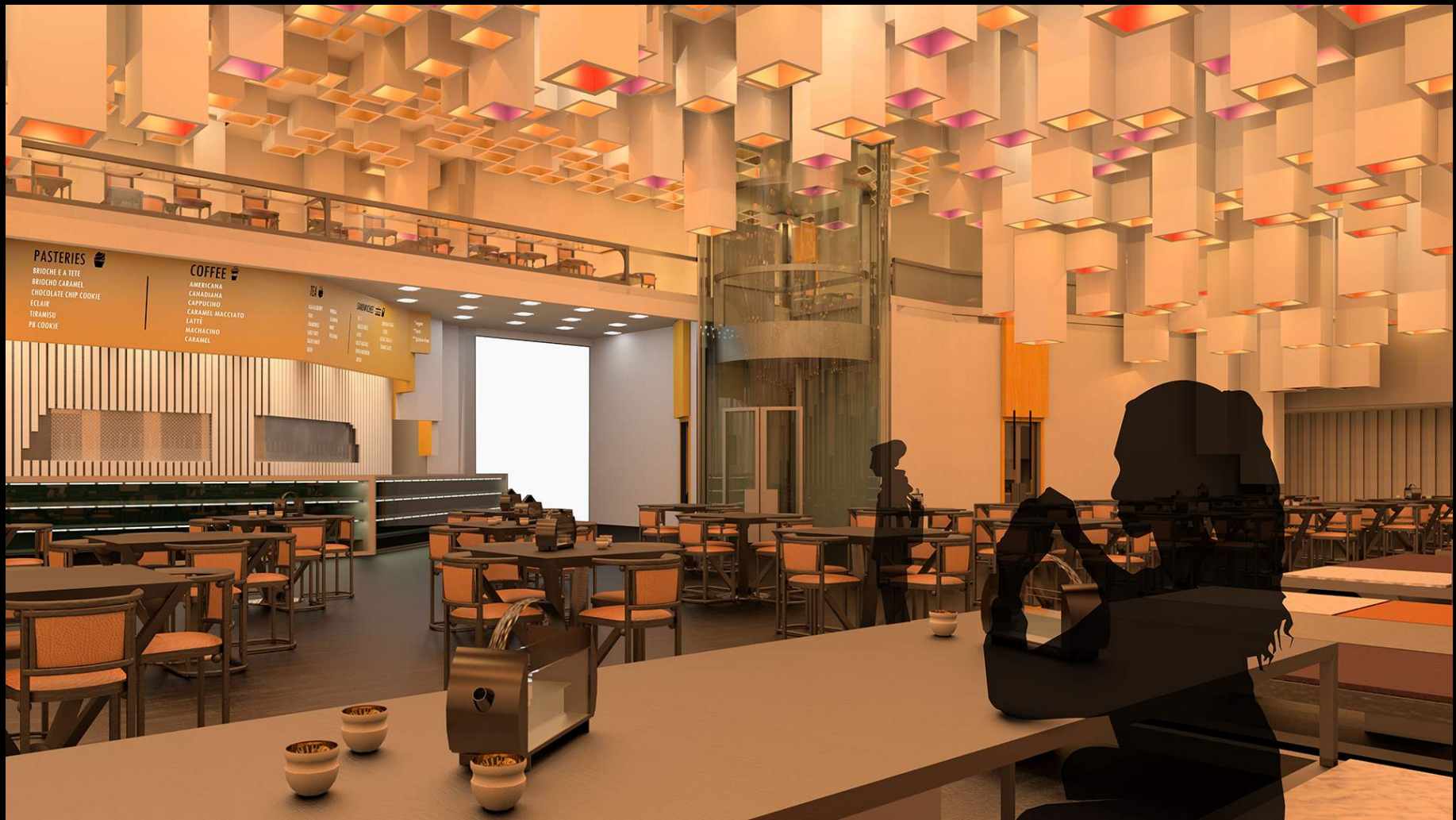

Student name: Angelica McKenzie

School name: New Jersey Institute of Technology

Program/department: Interior Design/School of Art + Design

Faculty name: Glenn Goldman

Project: Café





Student name: Chelsea Chamra

School name: New Jersey Institute of Technology

Program/department: Interior Design/School of Art + Design

Faculty name: Glenn Goldman

Project: Café





Student name: Chelsea Chamra

School name: New Jersey Institute of Technology

Program/department: Interior Design/School of Art + Design

Faculty name: Glenn Goldman

Project: Café





Student name: Jaime Rodriguez

School name: New Jersey Institute of Technology

Program/department: Interior Design/School of Art + Design

Faculty name: Glenn Goldman

Project: Café





Student name: Stephanie Marczak

School name: New Jersey Institute of Technology

Program/department: Interior Design/School of Art + Design

Faculty name: Glenn Goldman

Project: Café





Student name: James Lischick

School name: New Jersey Institute of Technology

Program/department: Interior Design/School of Art + Design

Faculty name: Glenn Goldman

Project: Café





Student name: Maria Romo

School name: New Jersey Institute of Technology

Program/department: Interior Design/School of Art + Design

Faculty name: Glenn Goldman

Project: Café



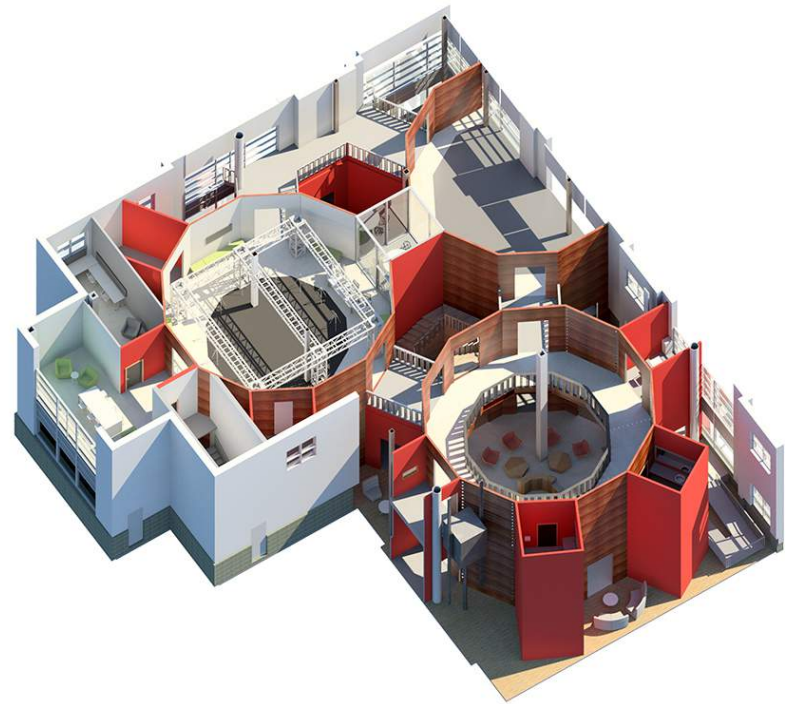

Student name: Maria Romo

School name: New Jersey Institute of Technology

Program/department: Interior Design/School of Art + Design

Faculty name: Glenn Goldman

Project: Creativity Center for NJIT



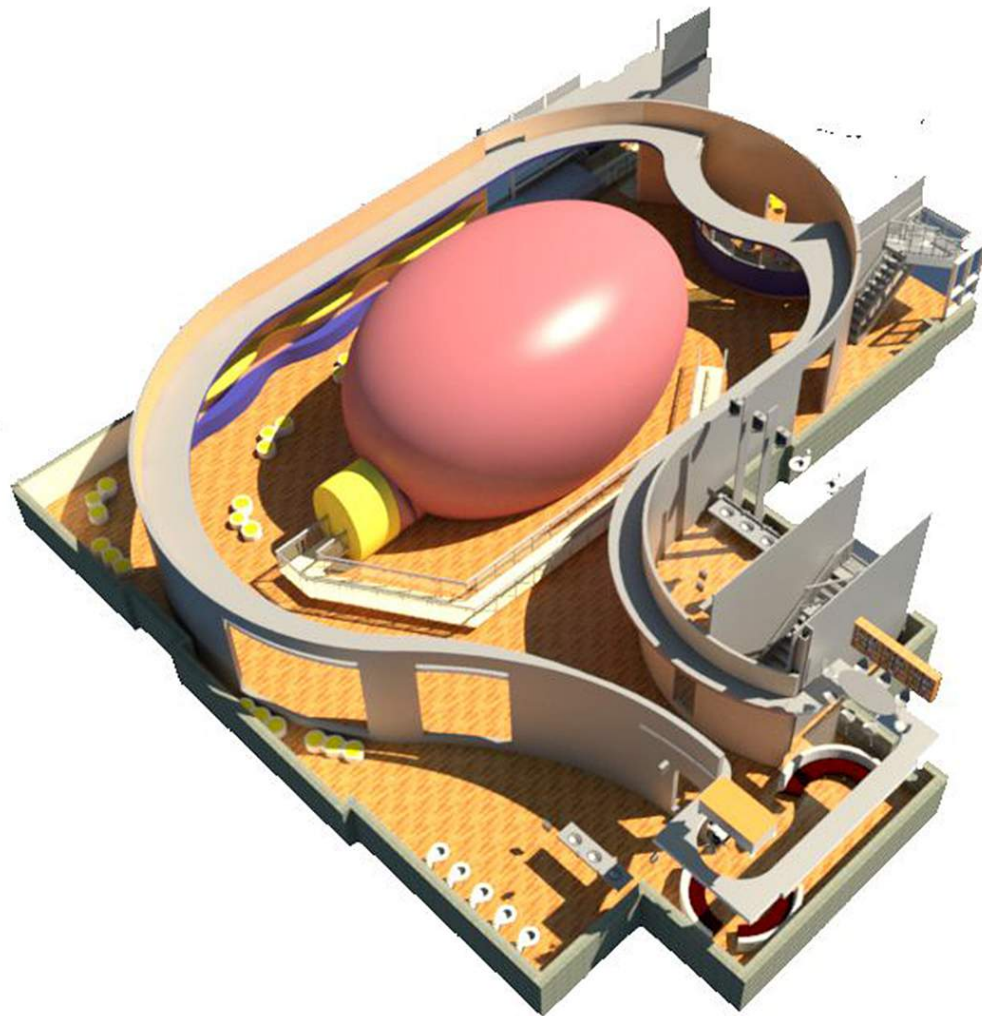

Student name: Merrit Morcos

School name: New Jersey Institute of Technology

Program/department: Interior Design/School of Art + Design

Faculty name: Glenn Goldman

Project: Creativity Center for NJIT



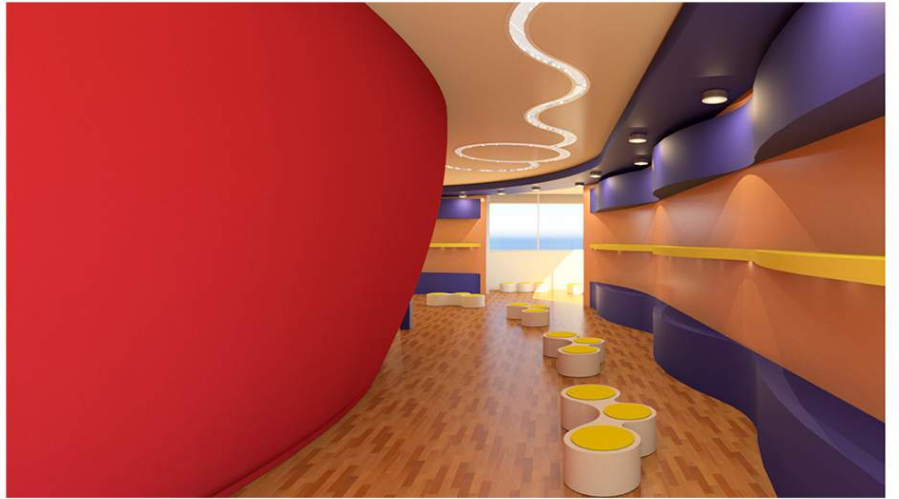

Student name: Merrit Morcos

School name: New Jersey Institute of Technology

Program/department: Interior Design/School of Art + Design

Faculty name: Glenn Goldman

Project: Creativity Center for NJIT





Student name: Stephanie Rodrigues

School name: New Jersey Institute of Technology

Program/department: Interior Design/School of Art + Design

Faculty name: Glenn Goldman

Project: Creativity Center for NJIT





Student name: Chelsea Chamra

School name: New Jersey Institute of Technology

Program/department: Interior Design/School of Art + Design

Faculty name: Glenn Goldman

Project: Creativity Center for NJIT





Student name: Angelica McKenzie

School name: New Jersey Institute of Technology

Program/department: Interior Design/School of Art + Design

Faculty name: Glenn Goldman

Project: Creativity Center for NJIT



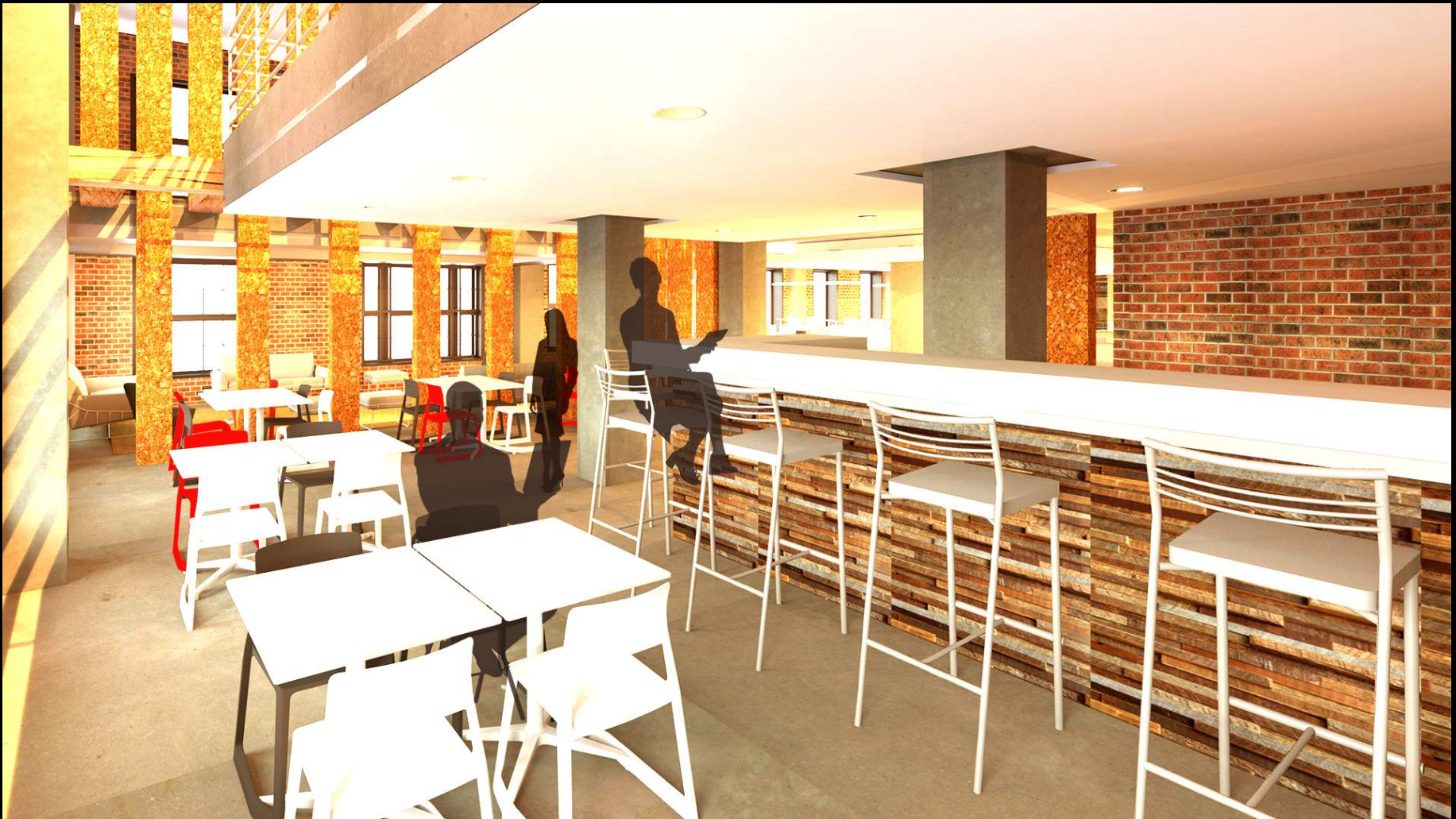

Student name: Mie Shimobayashi

School name: New Jersey Institute of Technology

Program/department: Interior Design/School of Art + Design

Faculty name: Sergio Mannino

Project: Corporate Headquarters/Commercial Design





Student name: Alyssa Diaz

School name: New Jersey Institute of Technology

Program/department: Interior Design/School of Art + Design

Faculty name: Sergio Mannino

Project: Corporate Headquarters/Commercial Design





Student name: Amanda DeWitte

School name: New Jersey Institute of Technology

Program/department: Interior Design/School of Art + Design

Faculty name: David Brothers

Project: Neighborhood Library





Student name: Cindy Caldas

School name: New Jersey Institute of Technology

Program/department: Interior Design/School of Art + Design

Faculty name: David Brothers

Project: Neighborhood Library





Student name: Brendan Horman

School name: New Jersey Institute of Technology

Program/department: Interior Design/School of Art + Design

Faculty name: David Brothers

Project: Neighborhood Library





Student name: Amos Dudley

School name: New Jersey Institute of Technology

Program/department: Digital Design/School of Art + Design

Faculty name: Augustus Wendell

Project: *VOICE*: Motion-Based Narrative (animation still)



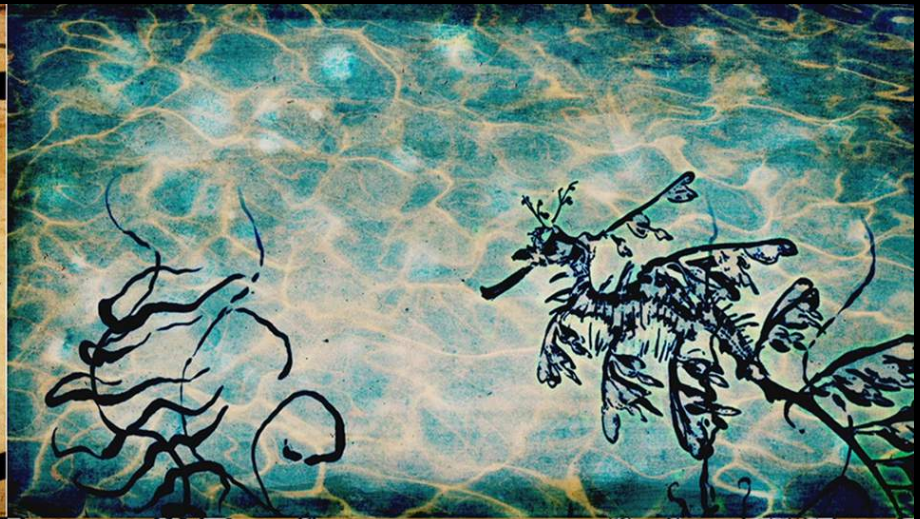

Student name: Kimberly Hastings

School name: New Jersey Institute of Technology

Program/department: Digital Design/School of Art + Design

Faculty name: Augustus Wendell

Project: *VOICE*: Motion-Based Narrative (animation still)





Student name: Mark Sanna

School name: New Jersey Institute of Technology

Program/department: Digital Design/School of Art + Design

Faculty name: Augustus Wendell

Project: *VOICE*: Motion-Based Narrative (animation still)



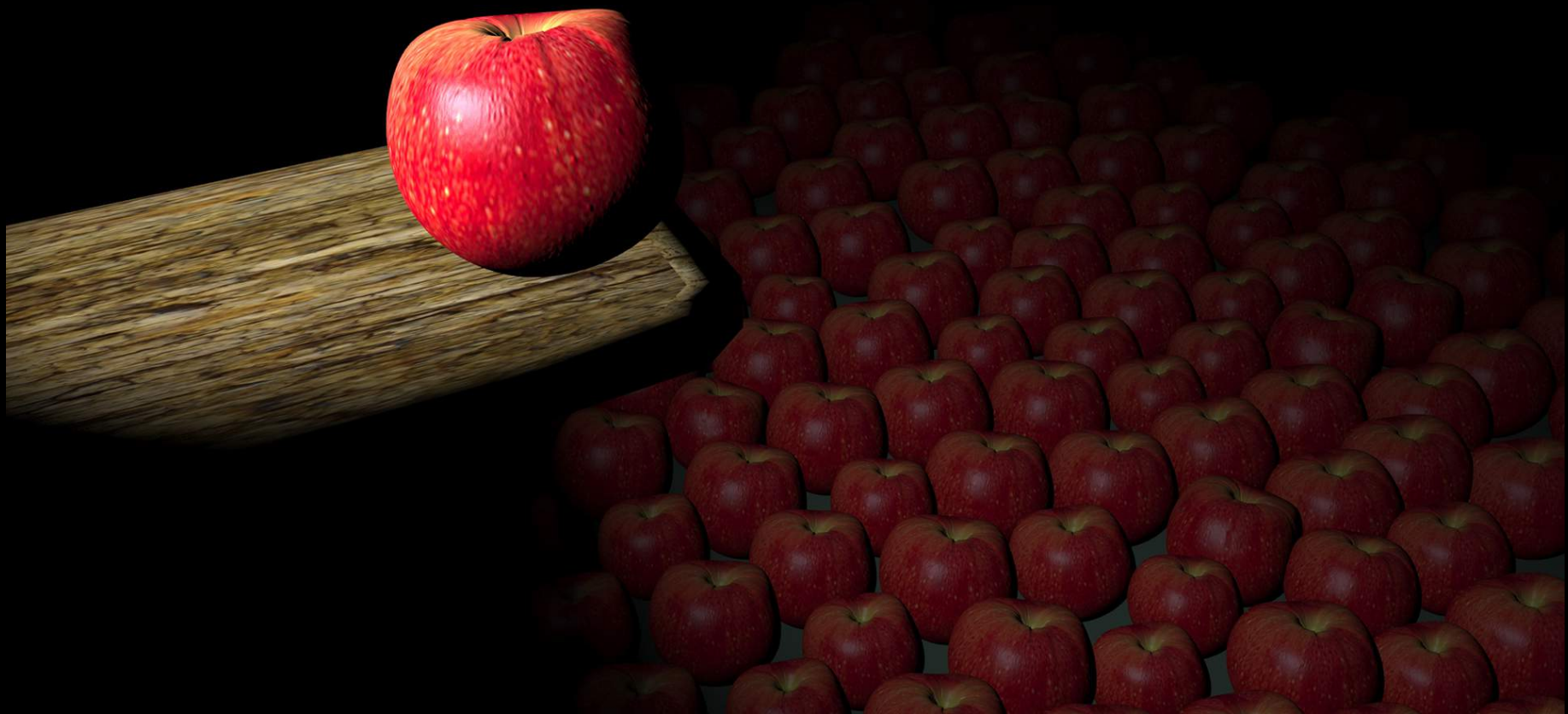

Student name: Shiao Alice Sung

School name: New Jersey Institute of Technology

Program/department: Digital Design/School of Art + Design

Faculty name: Augustus Wendell

Project: Form + Composition – Menacing Fruit





Student name: Gillian Rizza

School name: New Jersey Institute of Technology

Program/department: Digital Design/School of Art + Design

Faculty name: Augustus Wendell

Project: Form + Composition – Menacing Fruit





Student name: Paige Crosby

School name: New Jersey Institute of Technology

Program/department: Digital Design/School of Art + Design

Faculty name: Augustus Wendell

Project: Wonderland





Student name: Jeremy Borghi

School name: New Jersey Institute of Technology

Program/department: Digital Design/School of Art + Design

Faculty name: Augustus Wendell

Project: Wonderland





Student name: Brian Gunning

School name: New Jersey Institute of Technology

Program/department: Digital Design/School of Art + Design

Faculty name: Augustus Wendell

Project: Wonderland





Student name: Thanh Nguyen

School name: New Jersey Institute of Technology

Program/department: Digital Design/School of Art + Design

Faculty name: Glenn Goldman

Project: Imaginary Worlds – Sequels/Remakes



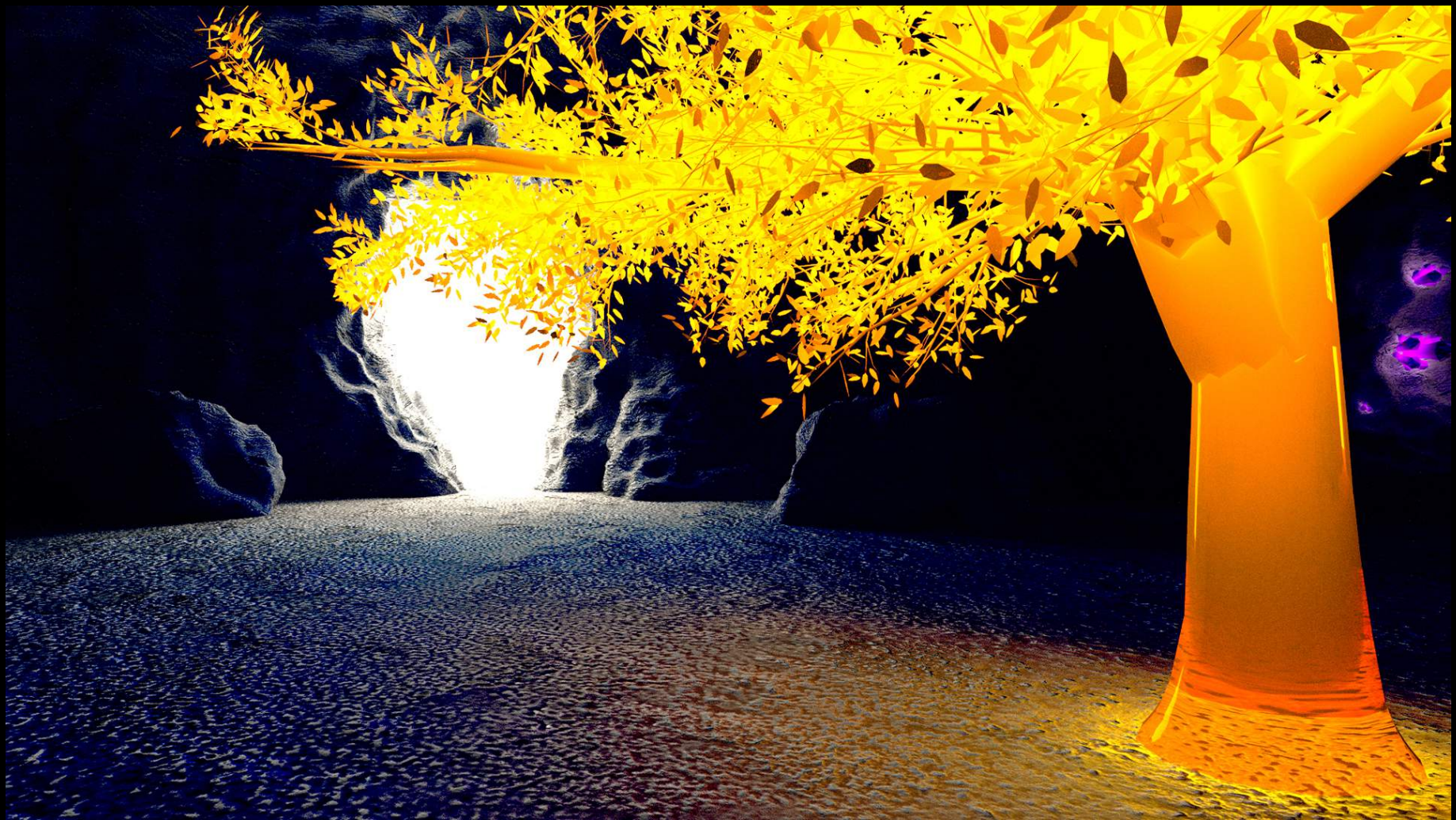

Student name: Mateusz Mrowiec

School name: New Jersey Institute of Technology

Program/department: Digital Design/School of Art + Design

Faculty name: Glenn Goldman

Project: Imaginary Worlds – Sequels/Remakes





Student name: Elvin Padilla

School name: New Jersey Institute of Technology

Program/department: Digital Design/School of Art + Design

Faculty name: Jessica Ross

Project: 2D Character Design and Linear Art





Student name: Angela Ang

School name: New Jersey Institute of Technology

Program/department: Digital Design/School of Art + Design

Faculty name: Jessica Ross

Project: 2D Character Design and Linear Art





Student name: Angela Ang

School name: New Jersey Institute of Technology

Program/department: Digital Design/School of Art + Design

Faculty name: Andrzej Zarzycki

Project: Digital Character Design



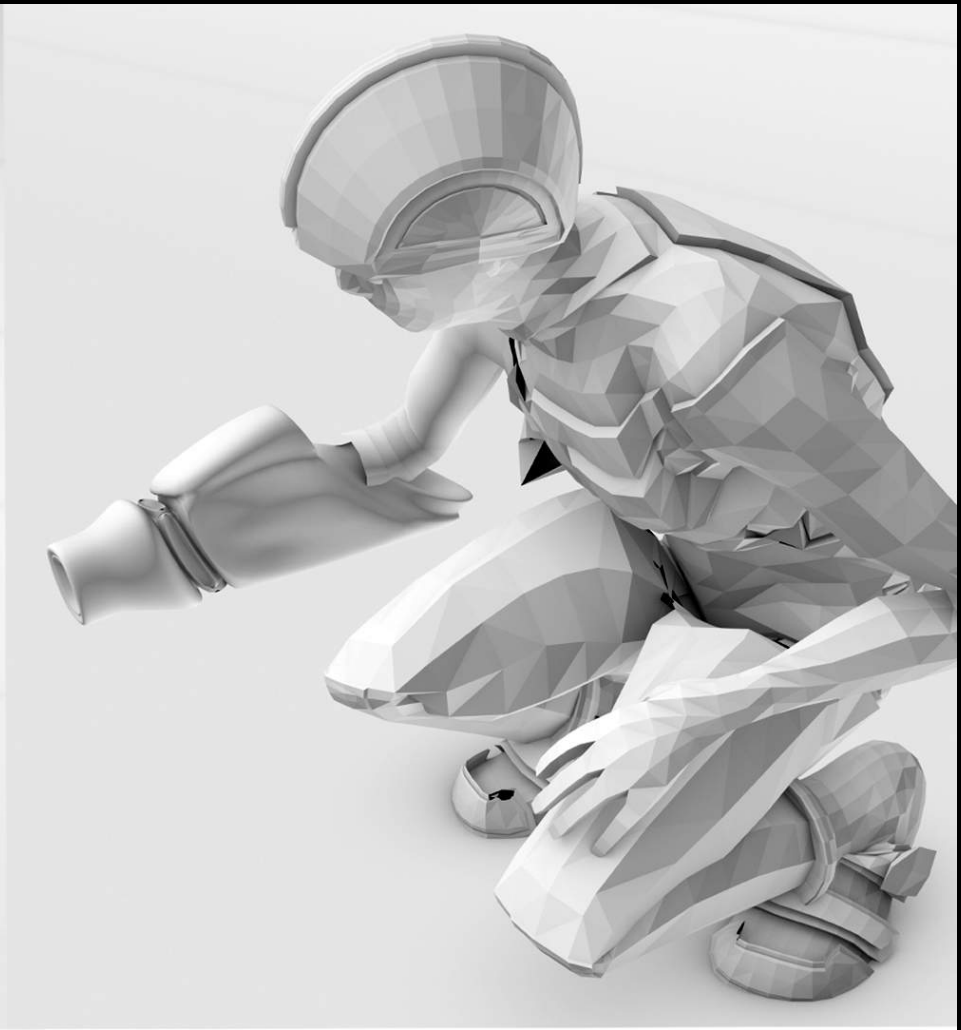
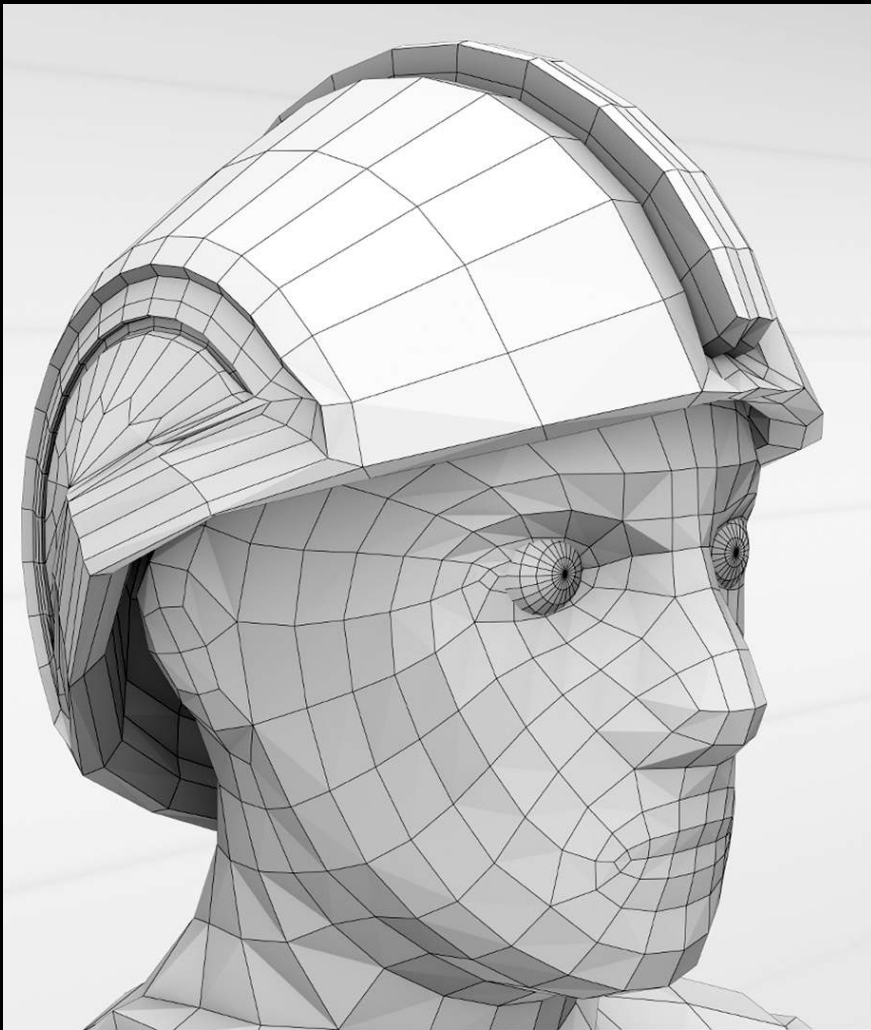

Student name: Dan Acosta

School name: New Jersey Institute of Technology

Program/department: Digital Design/School of Art + Design

Faculty name: Andrzej Zarzycki

Project: Digital Character Design





Student name: Elvin Padilla

School name: New Jersey Institute of Technology

Program/department: Digital Design/School of Art + Design

Faculty name: Andrzej Zarzycki

Project: Digital Character Design





Student name: Brandon Simms

School name: New Jersey Institute of Technology

Program/department: Digital Design/School of Art + Design

Faculty name: Andrzej Zarzycki

Project: Digital Character Design





Student name: Brandon Simms

School name: New Jersey Institute of Technology

Program/department: Digital Design/School of Art + Design

Faculty name: Andrzej Zarzycki

Project: Animation (Stills) Sustainability Story





Student name: Mark Santiago

School name: New Jersey Institute of Technology

Program/department: Digital Design/School of Art + Design

Faculty name: Andrzej Zarzycki

Project: Animation (Stills) Sustainability Story





Student name: Kwasi Amankona

School name: New Jersey Institute of Technology

Program/department: Digital Design/School of Art + Design

Faculty name: Andrzej Zarzycki

Project: Animation (Stills) Sustainability Story



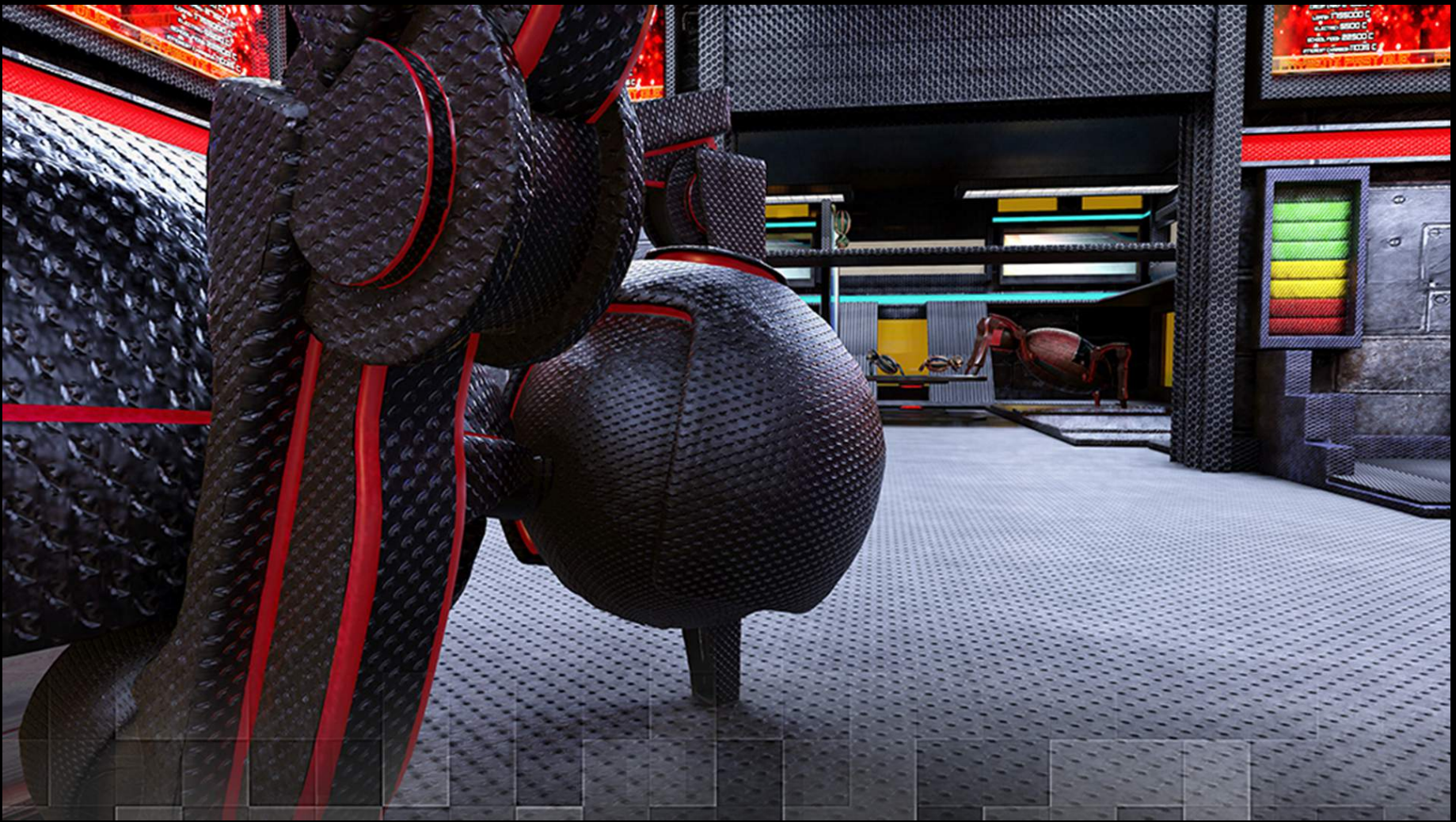

Student name: Kwasi Amankona

School name: New Jersey Institute of Technology

Program/department: Digital Design/School of Art + Design

Faculty name: Andrzej Zarzycki

Project: Animation (Stills) Sustainability Story



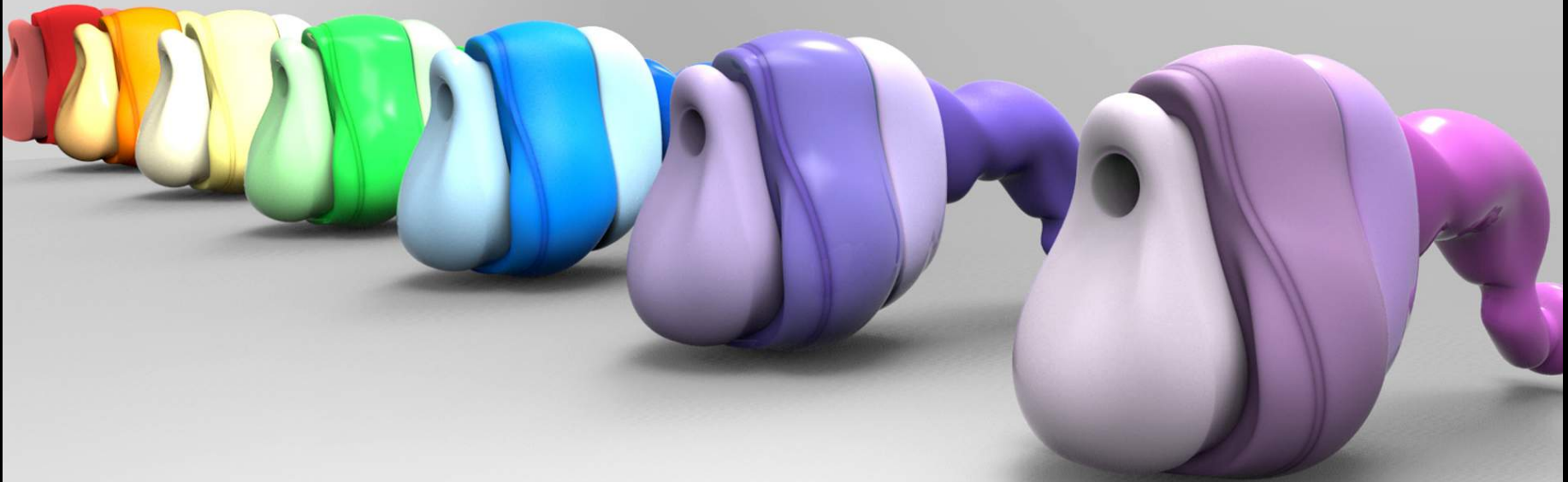

Student name: Natalia Szabla

School name: New Jersey Institute of Technology

Program/department: Industrial Design/School of Art + Design

Faculty name: José Alcalá

Project: Household Product Design (Sharpeners)



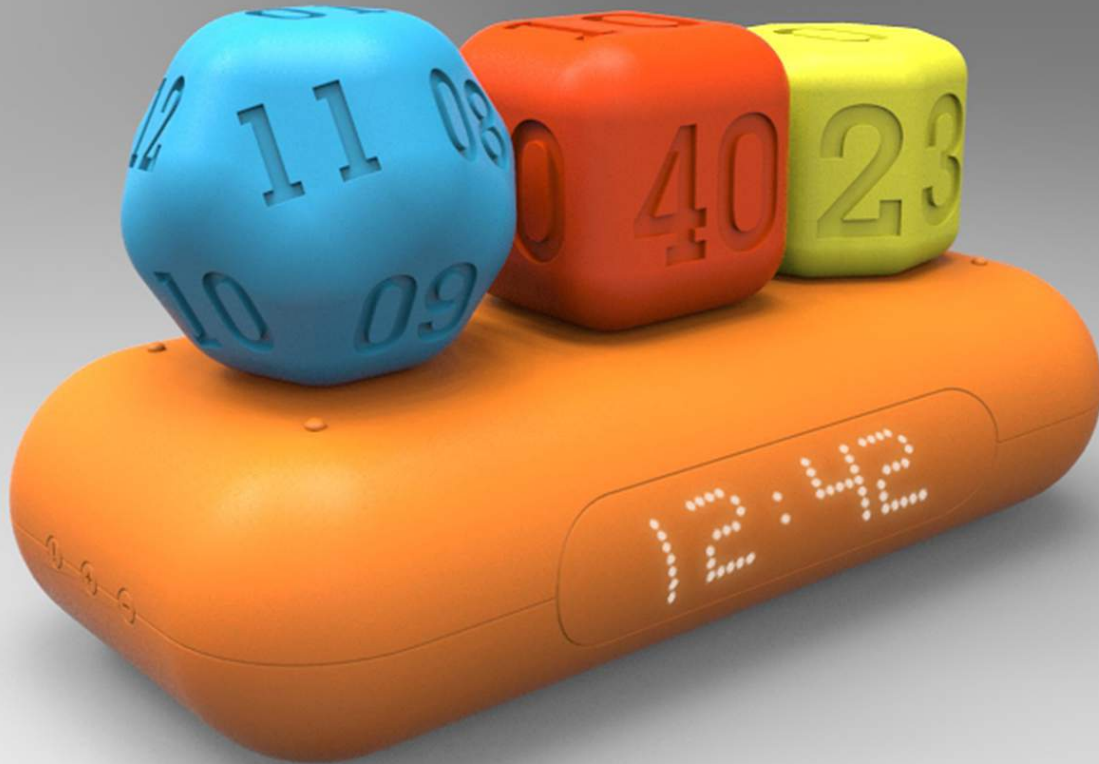

Student name: Martin Flores

School name: New Jersey Institute of Technology

Program/department: Industrial Design/School of Art + Design

Faculty name: Ran Lerner

Project: Household Smart Product Design (Calendar Clock)





<https://www.youtube.com/watch?v=ziNDxaXM8Ek>

Student name: Katharina Schuetz

School name: NHTV International Hoger Onderwijs, Breda

Program/department: Academy of Digital Entertainment, (IGAD)

Faculty name: Andrew Paquette & Martin Walker

Project: Architectural Visualization



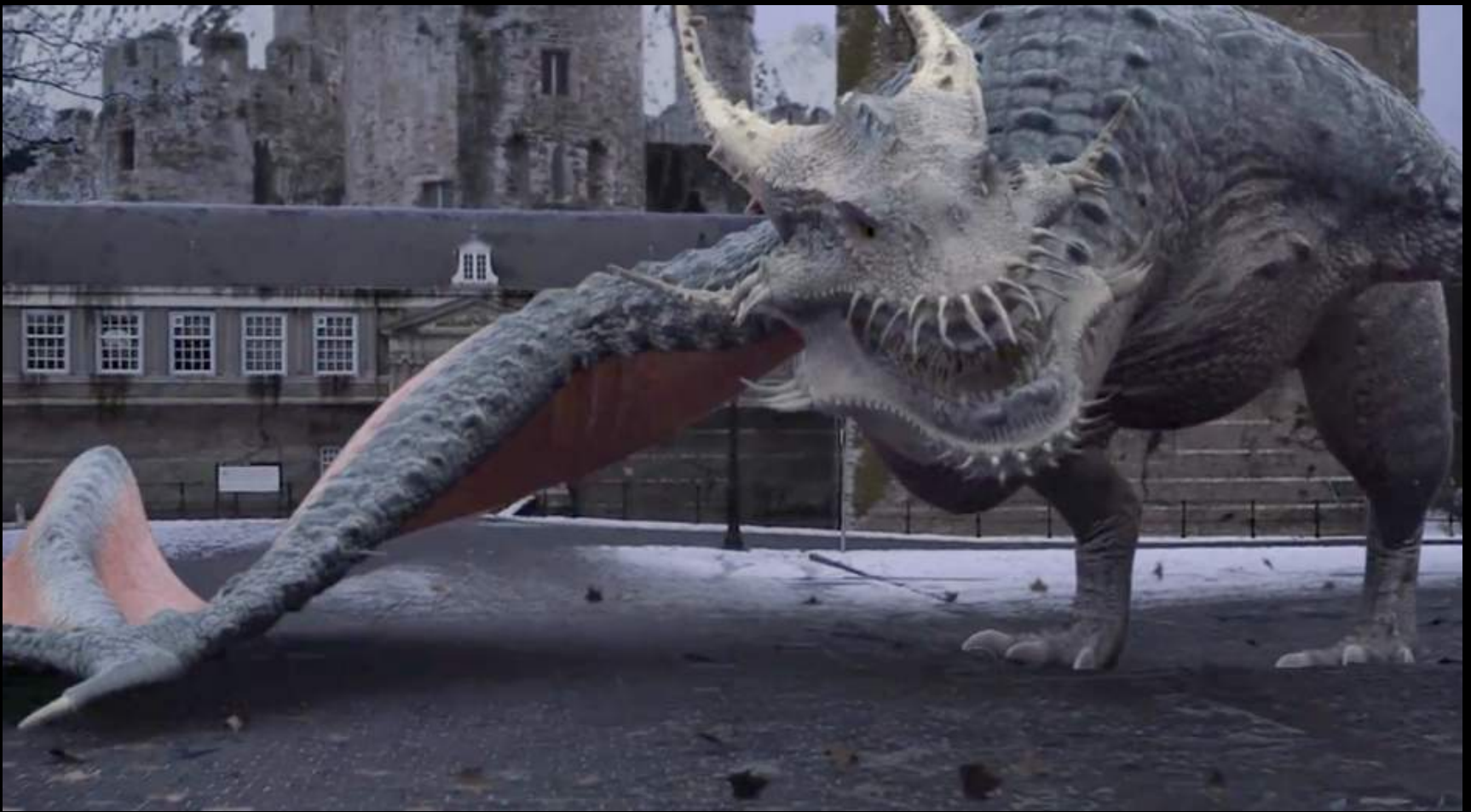

<https://www.youtube.com/watch?v=aPSdWlhqJi4>

Student name: Roel Herrebrugh

School name: NHTV International Hoger Onderwijs, Breda

Program/department: Academy of Digital Entertainment, (IGAD)

Faculty name: Kim Goossens

Project: Graduation





<https://www.youtube.com/watch?v=pGEMmurBvLk>

Student name: Lucas Bolt

School name: NHTV International Hoger Onderwijs, Breda

Program/department: Academy of Digital Entertainment, (IGAD)

Faculty name: Andrew Paquette & Martin Walker

Project: Architectural Visualization





<https://www.youtube.com/watch?v=6Fb1GmZuQJ8>

Student name: Matthias Kapuvari, Malte Langheim, Siim Rimm, Simon van den Broek, Rick van den Berg, Jordy Knoop, Bryan Noter, Simen Stroek, Jeroen Tanis

School name: NHTV International Hoger Onderwijs, Breda

Program/department: Academy of Digital Entertainment, (IGAD)

Faculty name: Andrew Paquette

Project: Audio Visual 5





<https://www.youtube.com/watch?v=8MbWHEy26PE>

Student name: Bodo Schutze

School name: NHTV International Hoger Onderwijs, Breda

Program/department: Academy of Digital Entertainment, (IGAD)

Faculty name: Andrew Paquette, Ronny Franken & Henry Hoogheimstra

Project: Graduation





https://www.youtube.com/watch?v=gk530cm2t_U

Student name: Mathijs Kapteijn, Tobias Koepp, Felix van den Berg, Tijs Bolder, Ramtin Saeedi, Sander Verhoeven, Remco van den Berg. Level design: Lisa Burgers. Music: Zack Hemsey

School name: NHTV International Hoger Onderwijs, Breda

Program/department: Academy of Digital Entertainment, (IGAD)

Faculty name: Ronny Franken & Neville Marcinkowski

Project: World Building 1 & 2





<https://www.youtube.com/watch?v=vGlp8hXy1A8>

Student name: Robert Joosten

School name: NHTV International Hoger Onderwijs, Breda

Program/department: Academy of Digital Entertainment, (IGAD)

Faculty name: Andrew Paquette

Project: Graduation



<https://www.youtube.com/watch?v=QWPZ4L1tWfk>

Student name: Malte Langheim

School name: NHTV International Hoger Onderwijs, Breda

Program/department: Academy of Digital Entertainment, (IGAD)

Faculty name: Andrew Paquette & Martin Walker

Project: Architectural Visualization





https://www.youtube.com/watch?v=pcznKd_ijVU

Student name:

ART: Elwin Westerink, Emiel Strijker, Tobias Koepp, Anneke van de Wouw, Niek van Gorp, Valentin Vockel, Sander Meijer, Arlon Swaders, Joey Relouw, Kaylee Mulder, Jori Stahlecker, Jeffrey Oort. Music by: Friedemann Findeisen. Sound design: Stijn Blokker, Bud Kolk. Voice actor: Dave Smit. Violin: Trienke Dijkstra. Cello: Juriaan Westerveld. Oboe: Miriam Schaap. Team name: Pangaea.

School name: NHTV International Hoger Onderwijs, Breda

Program/department: Academy of Digital Entertainment, (IGAD)

Faculty name: Andrew Paquette

Project: Audio Visual 5





<https://vimeo.com/79183682>

Student name: Jenny van Son

School name: NHTV International Hoger Onderwijs, Breda

Program/department: Academy of Digital Entertainment, (IGAD)

Faculty name: Kim Goossens

Project: Graduation





<https://www.youtube.com/watch?v=IZr4pdVhmxM>

Student name: Matthias Kapuvari

School name: NHTV International Hoger Onderwijs, Breda

Program/department: Academy of Digital Entertainment, (IGAD)

Faculty name: Andrew Paquette & Martin Walker

Project: Architectural Visualization





<https://www.youtube.com/watch?v=vqn53osknWY&list=UUIDiYuY3YcJNik1hCseDpcQ>

Student name: Nikhat Ali, Arthur Abeen, Timo van Hugten, Olaf van der Kuij, Bert Ruiter, Katharina Schuetz, Eline Slingerland & Ilias Tonev

School name: NHTV International Hoger Onderwijs, Breda

Program/department: Academy of Digital Entertainment, (IGAD)

Faculty name: Ronny Franken & Neville Marcinkowski

Project: Architectural Visualization





https://www.youtube.com/watch?v=IDd_-MhDPII

Student name: Griffin Berlstein

School name: Northwestern Regional No. 7 High School

Program/department: Art

Faculty name: Don Wass

Project: Object Model

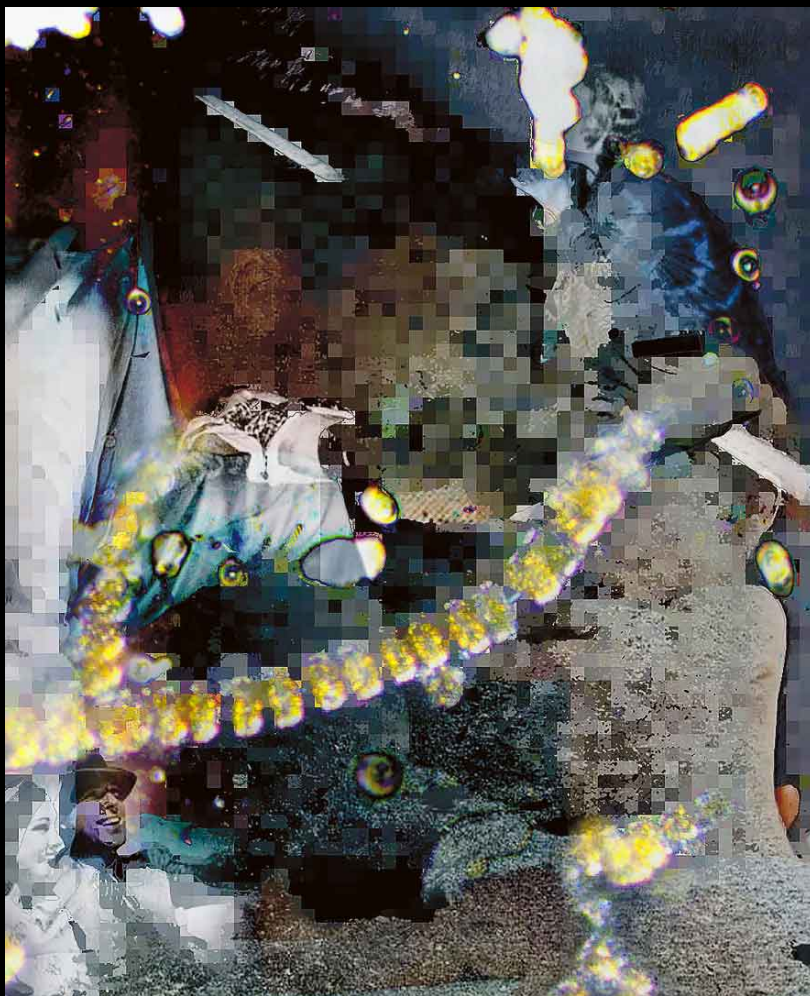

Student name: Sean Mullins

School name: Rhode Island School of Design

Program/department: NSF sponsored EPSCoR course

Faculty name: Cynthia Beth Rubin

Project: Plankton Portraits Final Project (with AR)



Student name: Kassia M Rico

School name: Rhode Island School of Design

Program/department: NSF sponsored EPSCoR course

Faculty name: Cynthia Beth Rubin

Project: Plankton Portraits Final Project (with AR)

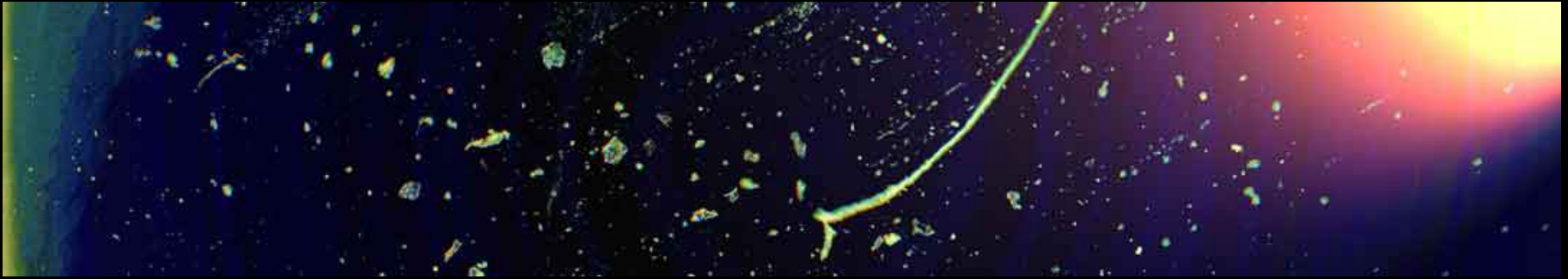

Student name: Tianyi (Jerry) Ma

School name: Rhode Island School of Design

Program/department: NSF sponsored EPSCoR course

Faculty name: Cynthia Beth Rubin

Project: Plankton Portraits Final Project (with AR)





Student name: MacKenzie Yamamoto-Lane
School name: Rhode Island School of Design
Program/department: NSF sponsored EPSCoR course
Faculty name: Cynthia Beth Rubin
Project: Plankton Portraits Final Project (with AR)



Student name: Gerardo Gandy

School name: Rhode Island School of Design

Program/department: NSF sponsored EPSCoR course

Faculty name: Cynthia Beth Rubin

Project: Plankton Portraits Environment Project



Student name: Monica Choi

School name: Rhode Island School of Design

Program/department: NSF sponsored EPSCoR course

Faculty name: Cynthia Beth Rubin

Project: Plankton Portraits Micro Photography





Student name: Abraham Arambolo

School name: Rhode Island School of Design

Program/department: Non-Major Studio Elective

Faculty name: Cynthia Beth Rubin

Project: Sensing the Past



Student name: Song Kang

School name: Rhode Island School of Design

Program/department: Non-Major Studio Elective

Faculty name: Cynthia Beth Rubin

Project: Sensing the Past



Student name: Tyra Bell

School name: Rhode Island School of Design

Program/department: Non-Major Studio Elective

Faculty name: Cynthia Beth Rubin

Project: Sensing the Past



Student name: Ye Wang

School name: Rhode Island School of Design

Program/department: Non-Major Studio Elective

Faculty name: Cynthia Beth Rubin

Project: Sensing the Past



Student name: Evan Robbins

School name: Rhode Island School of Design

Program/department: Non-Major Studio Elective

Faculty name: Cynthia Beth Rubin

Project: Sensing the Past



Student name: Catherine Caro

School name: Rhode Island School of Design

Program/department: Non-Major Studio Elective

Faculty name: Cynthia Beth Rubin

Project: Manuscripts from Across Time and Culture



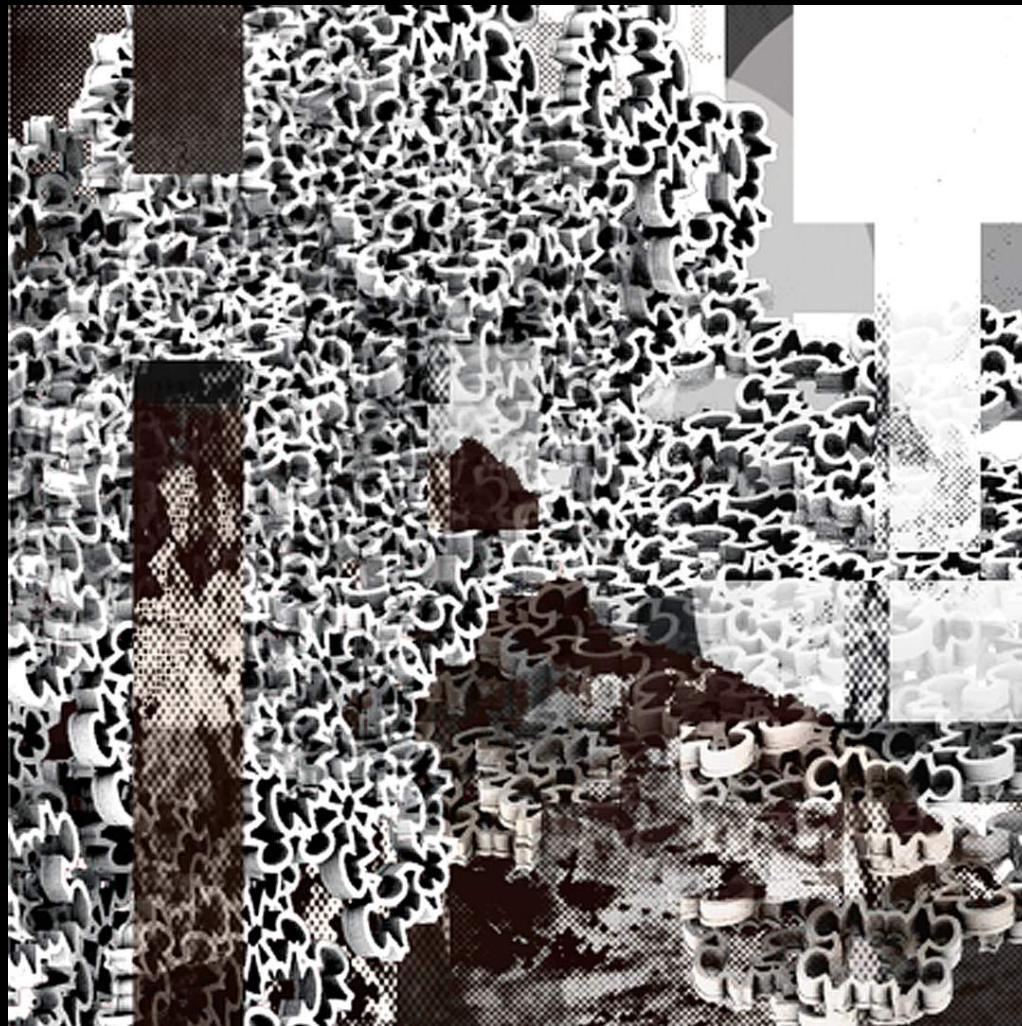

Student name: Mina Onar

School name: Rhode Island School of Design

Program/department: Non-Major Studio Elective

Faculty name: Cynthia Beth Rubin

Project: Manuscripts from Across Time and Culture



Student name: Spike Meatyard

School name: Rhode Island School of Design

Program/department: Non-Major Studio Elective

Faculty name: Cynthia Beth Rubin

Project: Manuscripts from Across Time and Culture



Student name: Maria Bedoya

School name: Rhode Island School of Design

Program/department: Non-Major Studio Elective

Faculty name: Cynthia Beth Rubin

Project: Manuscripts from Across Time and Culture

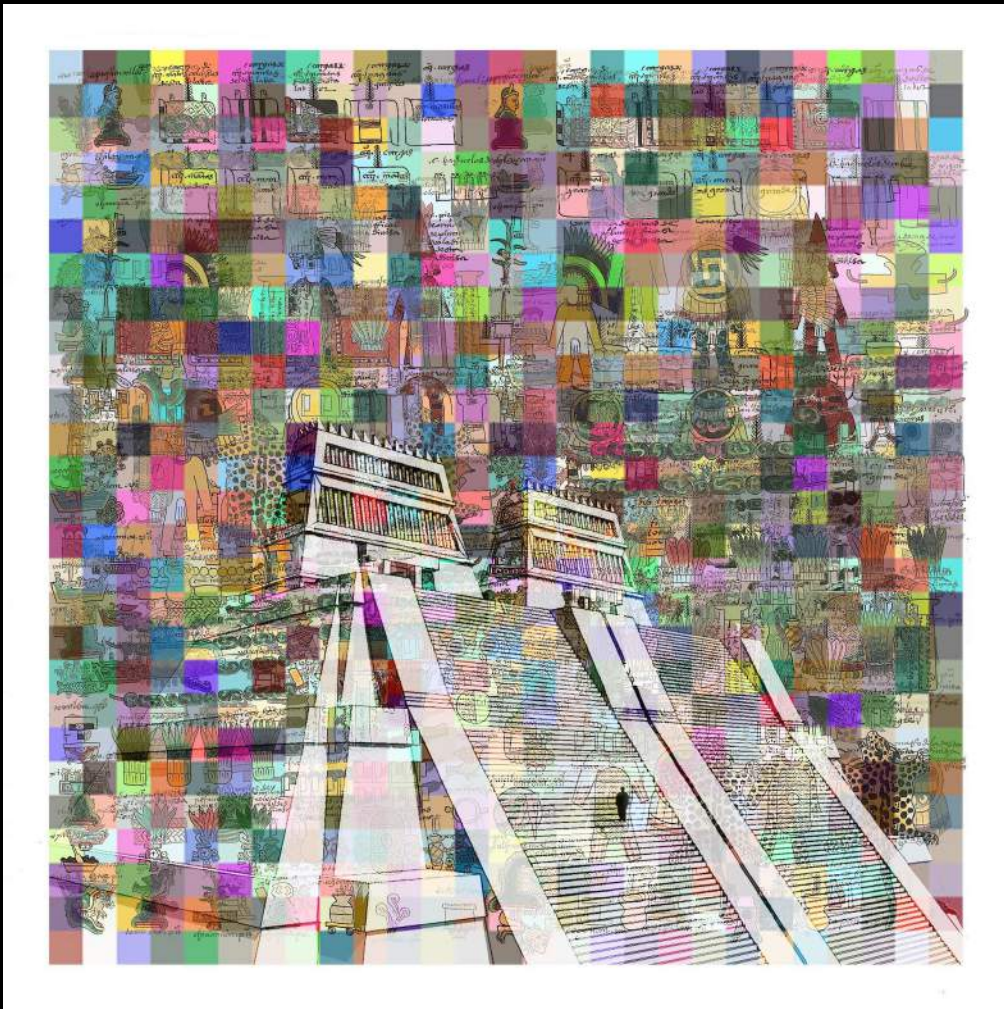

Student name: Gerardo Gandy

School name: Rhode Island School of Design

Program/department: Non-Major Studio Elective

Faculty name: Cynthia Beth Rubin

Project: Manuscripts from Across Time and Culture



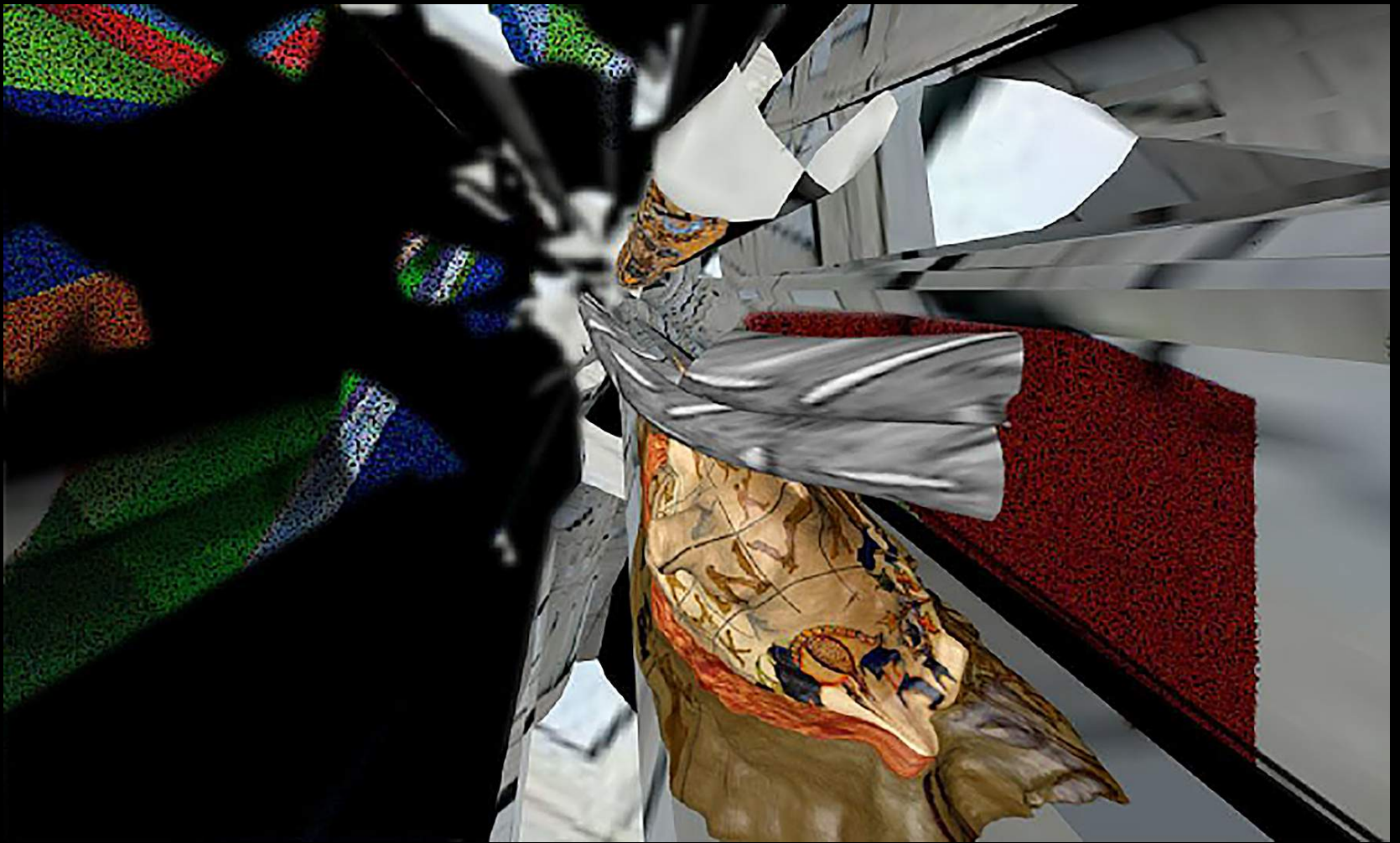

Student name: Jonathan Hilgart

School name: Rhode Island School of Design

Program/department: Non-Major Studio Elective

Faculty name: Cynthia Beth Rubin

Project: Manuscripts from Across Time and Culture



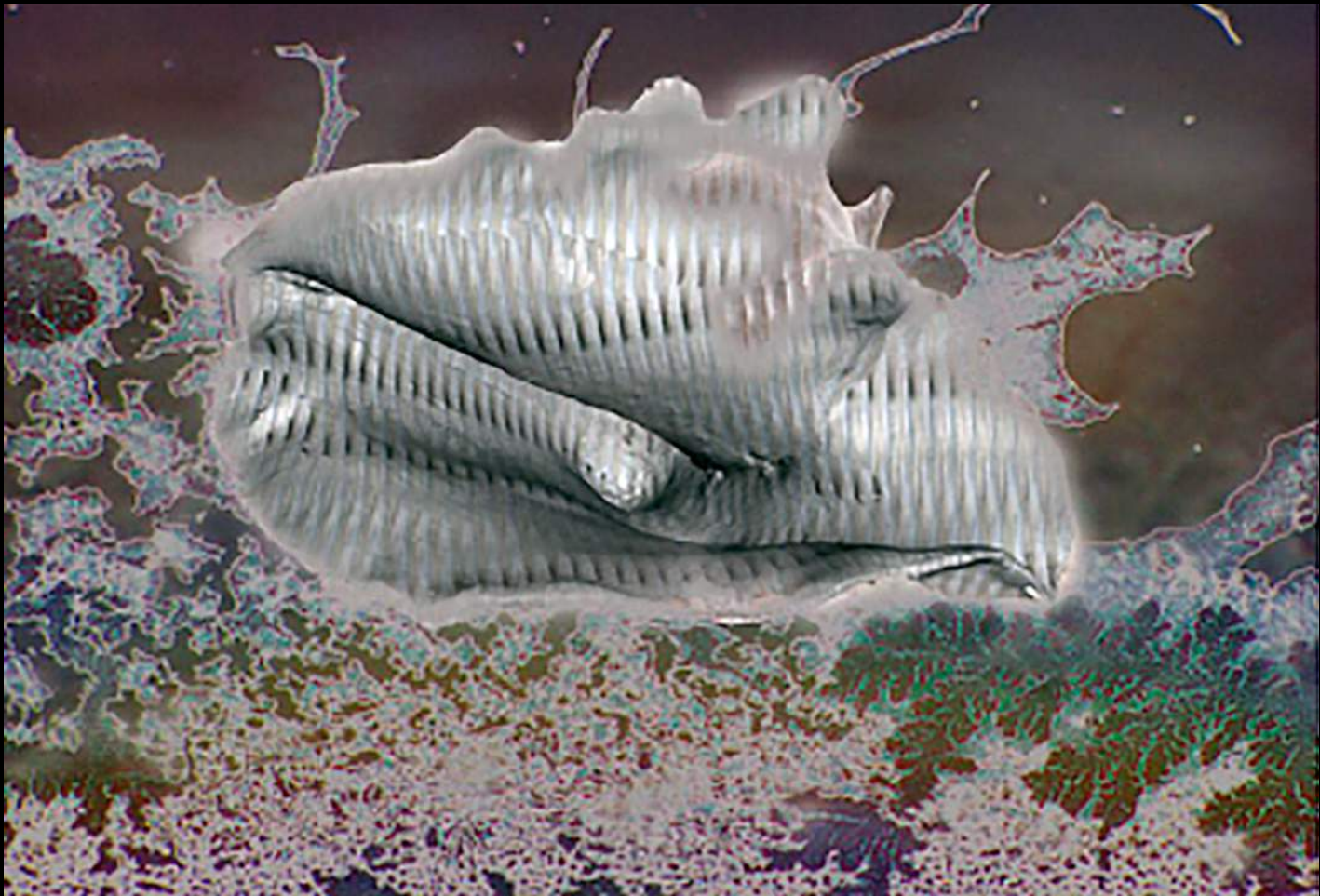

Student name: Mercan Denizci

School name: Rhode Island School of Design

Program/department: Non-Major Studio Elective

Faculty name: Cynthia Beth Rubin

Project: Cultural Objects from Everyday Life



Student name: Eric Kimberley

School name: Rochester Institute of Technology

Program/department: 3D Digital Design

Faculty name: Shaun Foster

Project: Senior Thesis





Student name: Chris Dandrow

School name: Rochester Institute of Technology

Program/department: 3D Digital Design

Faculty name: Shaun Foster

Project: Senior Thesis



Student name: Lauren Colmes, Qina Chen

School name: Rochester Institute of Technology

Program/department: School of Design, 3D Digital Design

Faculty name: David Halbstein

Project: Photo/3D Collaborative Image





Student name: Henry Huntington

School name: Rochester Institute of Technology

Program/department: School of Design, 3D Digital Design

Faculty name: David Halbstein

Project: Hallway Project



Student name: Jarell Pryor

School name: Rochester Institute of Technology

Program/department: School of Design, 3D Digital Design

Faculty name: David Halbstein

Project: Interior Space





Student name: Chiao Ling Hong

School name: Rochester Institute of Technology

Program/department: School of Design, 3D Digital Design

Faculty name: David Halbstein

Project: Interior Space





<https://www.youtube.com/watch?v=laoB5KSHMDA&feature=youtu.be>

Student name: Melissa Chiu

School name: Rochester Institute of Technology

Program/department: School of Design, 3D Digital Design

Faculty name: David Halbstein

Project: Interior Space





<https://www.youtube.com/watch?v=3DUzxYLF5gE&feature=youtu.be>

Student name: Brittany Geffert

School name: Rochester Institute of Technology

Program/department: School of Design, 3D Digital Design

Faculty name: David Halbstein

Project: Physically Correct Surfacing





https://www.youtube.com/watch?v=Ac2l_gkk5zY&feature=youtu.be

Student name: Raymond Summers

School name: Rochester Institute of Technology

Program/department: School of Design, 3D Digital Design

Faculty name: David Halbstein

Project: Interior Space





https://www.youtube.com/watch?v=nSxIPNRd_7U&feature=youtu.be

Student name: Matthew Tidridge

School name: Rochester Institute of Technology

Program/department: School of Design, 3D Digital Design

Faculty name: David Halbstein

Project: Physically Correct Surfacing





<https://www.youtube.com/watch?v=AUOJ1Gpawc&feature=youtu.be>

Student name: Raymond Szegeti

School name: Rochester Institute of Technology

Program/department: School of Design, 3D Digital Design

Faculty name: David Halbstein

Project: Interior Space





<https://www.youtube.com/watch?v=7MetX6i7LfY&feature=youtu.be>

Student name: Damian Kwiatkowski

School name: Rochester Institute of Technology

Program/department: School of Design, 3D Digital Design

Faculty name: David Halbstein

Project: Hallway





<https://www.youtube.com/watch?v=lv8OfLUgoKc&feature=youtu.be>

Student name: Damian Kwiatkowski

School name: Rochester Institute of Technology

Program/department: School of Design, 3D Digital Design

Faculty name: David Halbstein

Project: Fire, Earth, Air, Water





<https://vimeo.com/97070226>

Student name: Keith Silva

School name: San Jose State University

Program/department: Animation/Illustration

Faculty name: David Chai

Project: Hello Debra





<https://vimeo.com/97070223>

Student name: Megan Auer

School name: San Jose State University

Program/department: Animation/Illustration

Faculty name: David Chai

Project: Dog Gonnit'





<https://vimeo.com/97070224>

Student name: Pattie Schleicher

School name: San Jose State University

Program/department: Animation/Illustration

Faculty name: David Chai

Project: Enlighten





<https://vimeo.com/97070225>

Student name: Alex Turner

School name: San Jose State University

Program/department: Animation/Illustration

Faculty name: David Chai

Project: Purse Nightmare



<https://vimeo.com/97179237>

Student name: Megan Hart

School name: San Jose State University

Program/department: Animation/Illustration

Faculty name: David Chai

Project: End of the Vine





<https://vimeo.com/99648509>

Student name: Panop Koonwat

School name: School of Visual Arts

Program/department: MFA Computer Art

Faculty name: Milan DeVecchio

Project: Cupidiculous

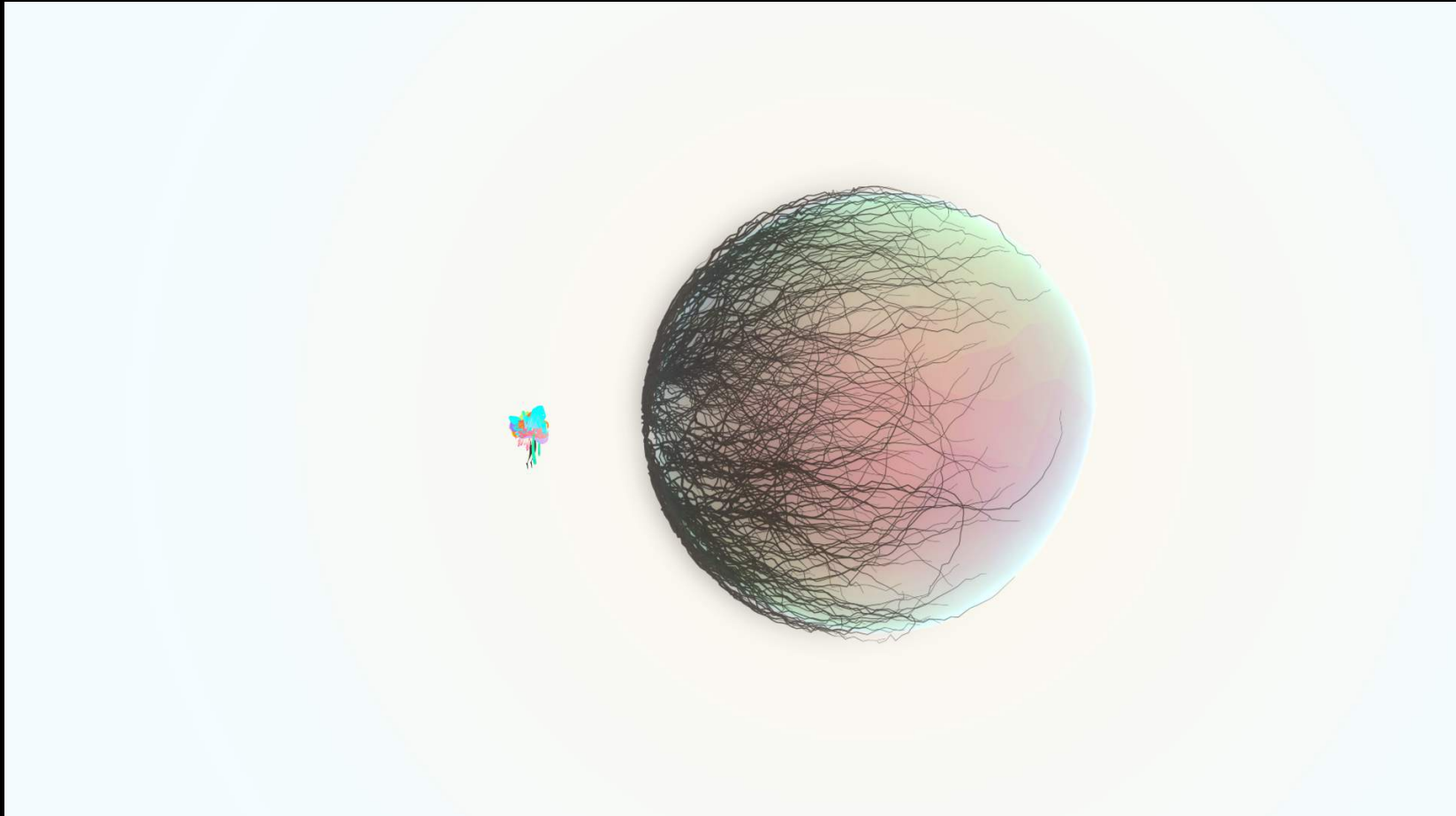

<https://vimeo.com/99665787>

Student name: Mirage

School name: School of Visual Arts

Program/department: MFA Computer Art

Faculty name: Milan DeVecchio

Project: Yaya Xu





<https://vimeo.com/99758754>

Student name: Marcescent

School name: School of Visual Arts

Program/department: MFA Computer Art

Faculty name: Milan DeVecchio

Project: Hung Ling Wu





<https://vimeo.com/99760959>

Student name: Yandong Qiu

School name: School of Visual Arts

Program/department: MFA Computer Art

Faculty name: Milan DeVecchio

Project: Kia Rex

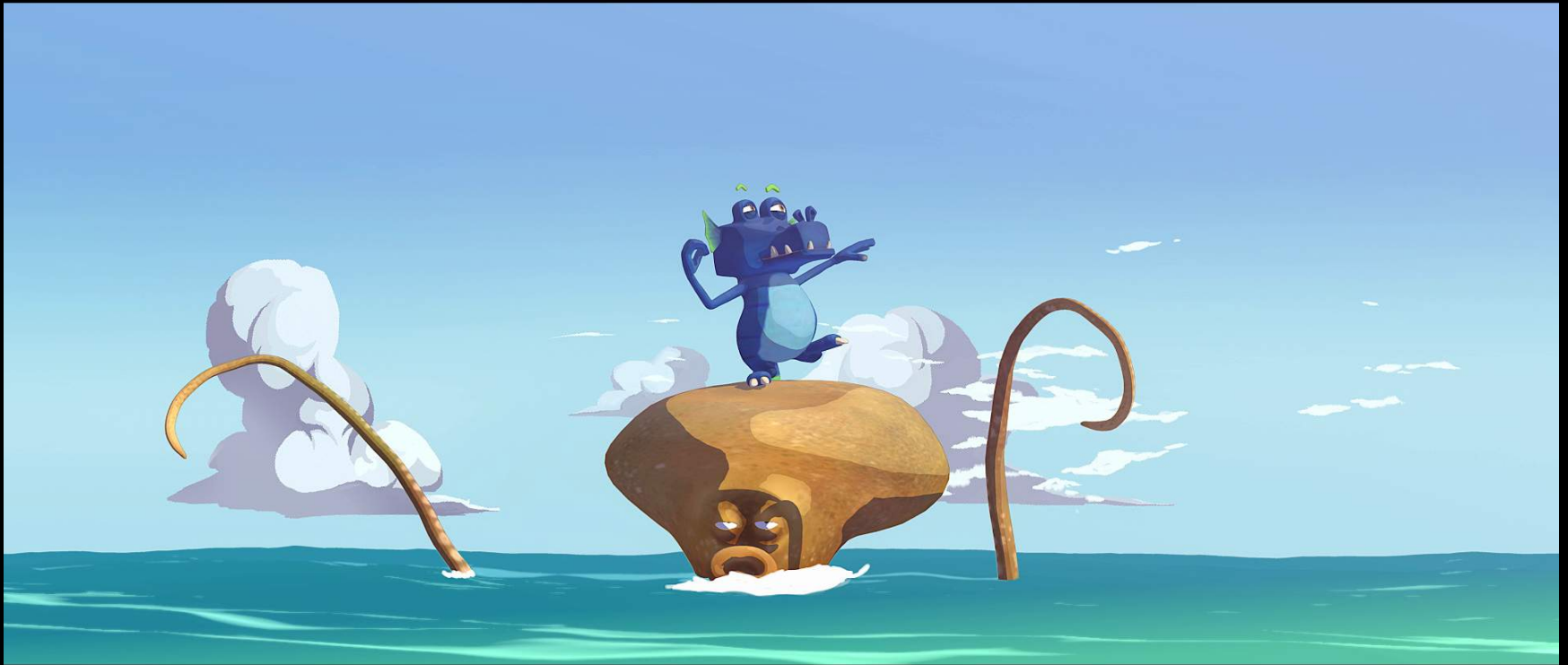

<https://vimeo.com/99762579>

Student name: Wendi Wu & Wenting Wu

School name: School of Visual Arts

Program/department: MFA Computer Art

Faculty name: Milan DeVecchio

Project: Cocodile



OUR PET BIRD



<https://vimeo.com/98080337>

Student name: Yu-Fei Kao

School name: School of Visual Arts

Program/department: MFA Computer Art

Faculty name: Milan DeVecchio

Project: Revenge





<https://vimeo.com/96220889>

Student name: Nai Wei Liu

School name: School of Visual Arts

Program/department: MFA Computer Art

Faculty name: Milan DeVecchio

Project: Something Important



<https://vimeo.com/92330490>

Student name: Wei Lu

School name: School of Visual Arts

Program/department: MFA Computer Art

Faculty name: Milan DeVecchio

Project: Run Crab Run!





<https://vimeo.com/99766996>

Student name: Laura LeBlanc

School name: School of Visual Arts

Program/department: MFA Computer Art

Faculty name: Milan DeVecchio

Project: Lucky Sevens



<https://vimeo.com/95791971>

Student name: Allison Botkin, Michael Bourbeau, & Meng Chwen Tien

School name: School of Visual Arts

Program/department: MFA Computer Art

Faculty name: Milan DeVecchio

Project: Treasure Nest





<https://vimeo.com/92330489>

Student name: Chun Wei Kuo

School name: School of Visual Arts

Program/department: MFA Computer Art

Faculty name: Milan DeVecchio

Project: Rosemary



<https://vimeo.com/96220887>

Student name: Hui Chi Chuang

School name: School of Visual Arts

Program/department: MFA Computer Art

Faculty name: Milan DeVecchio

Project: Across The Light



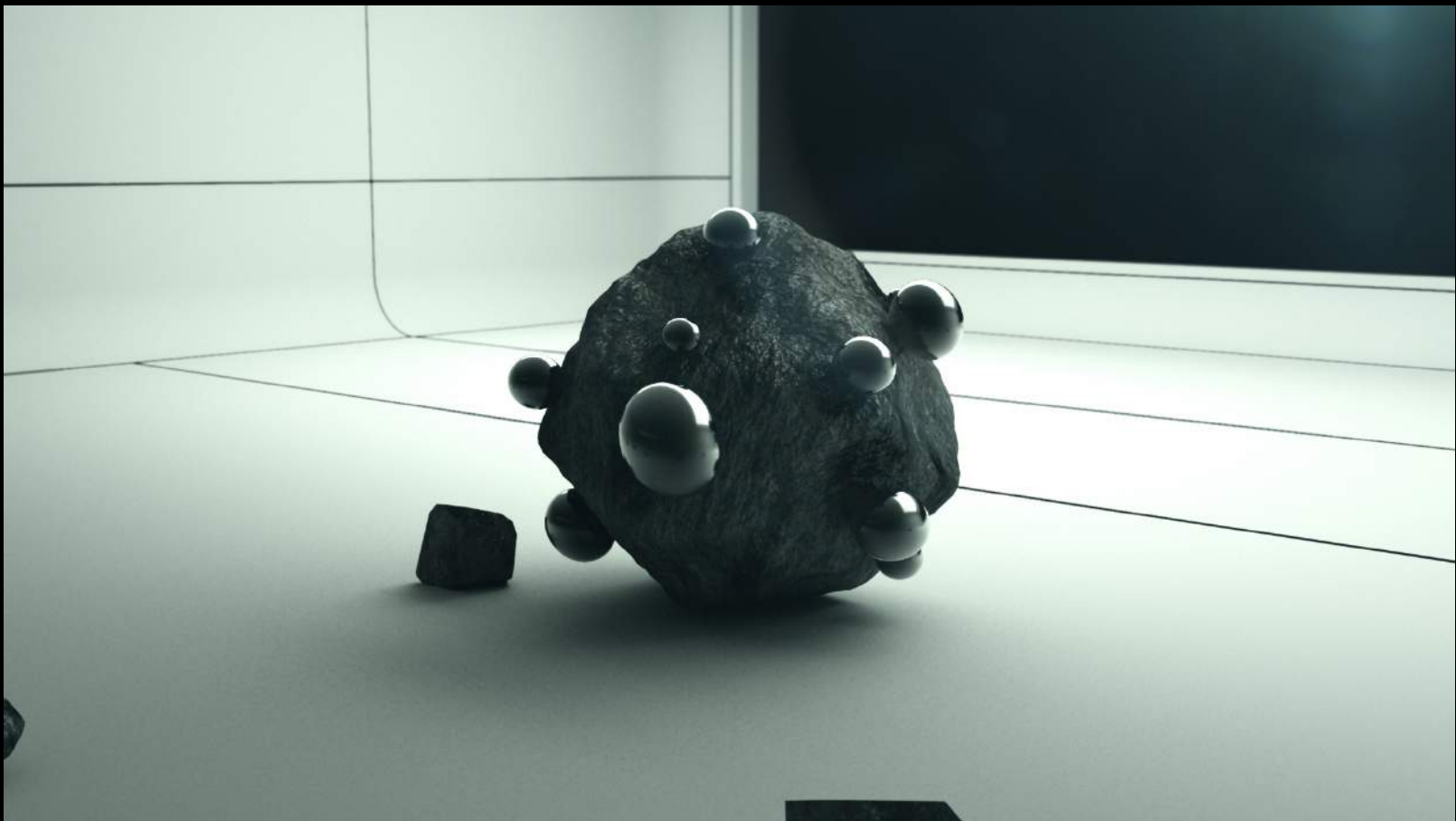

<https://vimeo.com/98081101>

Student name: Xingjian Wu

School name: School of Visual Arts

Program/department: MFA Computer Art

Faculty name: Milan DeVecchio

Project: Rock Got Cancer



<https://vimeo.com/album/2915695/video/99558651>

Student name: Harsha Biswajit

School name: School of Visual Arts

Program/department: MFA Computer Art

Faculty name: Milan DeVecchio

Project: The Animal is Absent





<https://vimeo.com/album/2463307/video/70570638>

Student name: Daniel Sierra

School name: School of Visual Arts

Program/department: MFA Computer Art

Faculty name: Milan DeVecchio

Project: Oscillate





<https://www.youtube.com/watch?v=g1KgOoiir2I>

Student name: Class of 2016 Students

School name: Southwest Career and Technical Academy

Program: Web Development/Video Game Design

Faculty name: Maureen Clark

Project: Little Red Flying Hood, The Movie

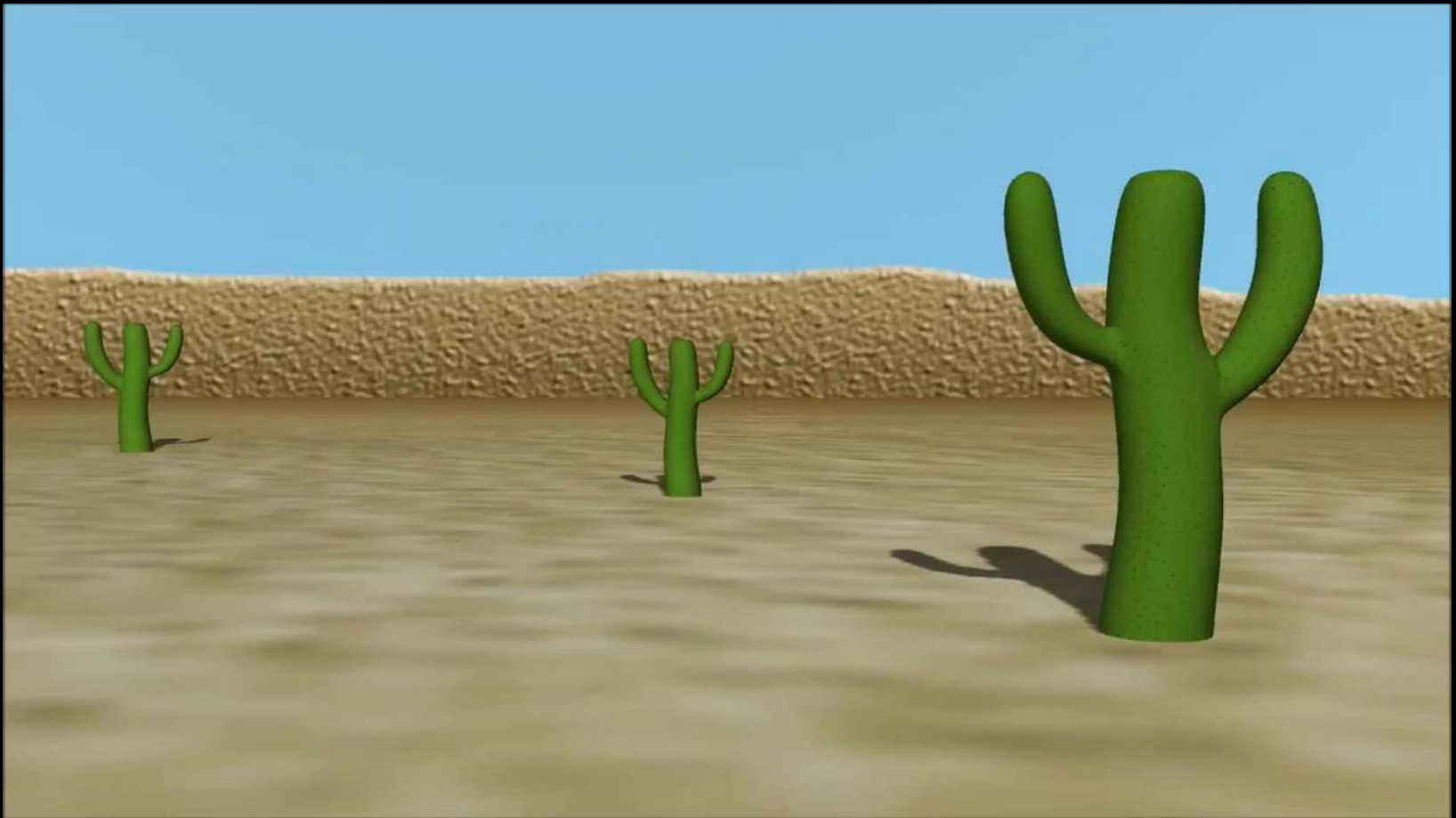

<https://www.youtube.com/watch?v=8s1xj-P1N5k>

Student name: Devin Cuevas-Alva, Alex Kastanek, Jared Hunter

School name: Southwest Career and Technical Academy

Program: Video Game Development

Faculty name: Maureen Clark

Project: Deathclipse vs Acavez, Junior Capstone Project





<https://www.youtube.com/watch?v=Kw3Nxji0jm0>

Student name: Nicholas Kolettis, Bryce Monaco, Connor Jones

School name: Southwest Career and Technical Academy

Program: Video Game Development

Faculty name: Maureen Clark

Project: G-ARU, Junior Capstone Project





Student name: Addison Sorca

School name: Southwest Career and Technical Academy

Program: Web Design and Development

Faculty name: Maureen Clark

Project: Self Portrait Close Up





Student name: Addison Sorca

School name: Southwest Career and Technical Academy

Program: Web Design and Development

Faculty name: Maureen Clark

Project: Self Portait

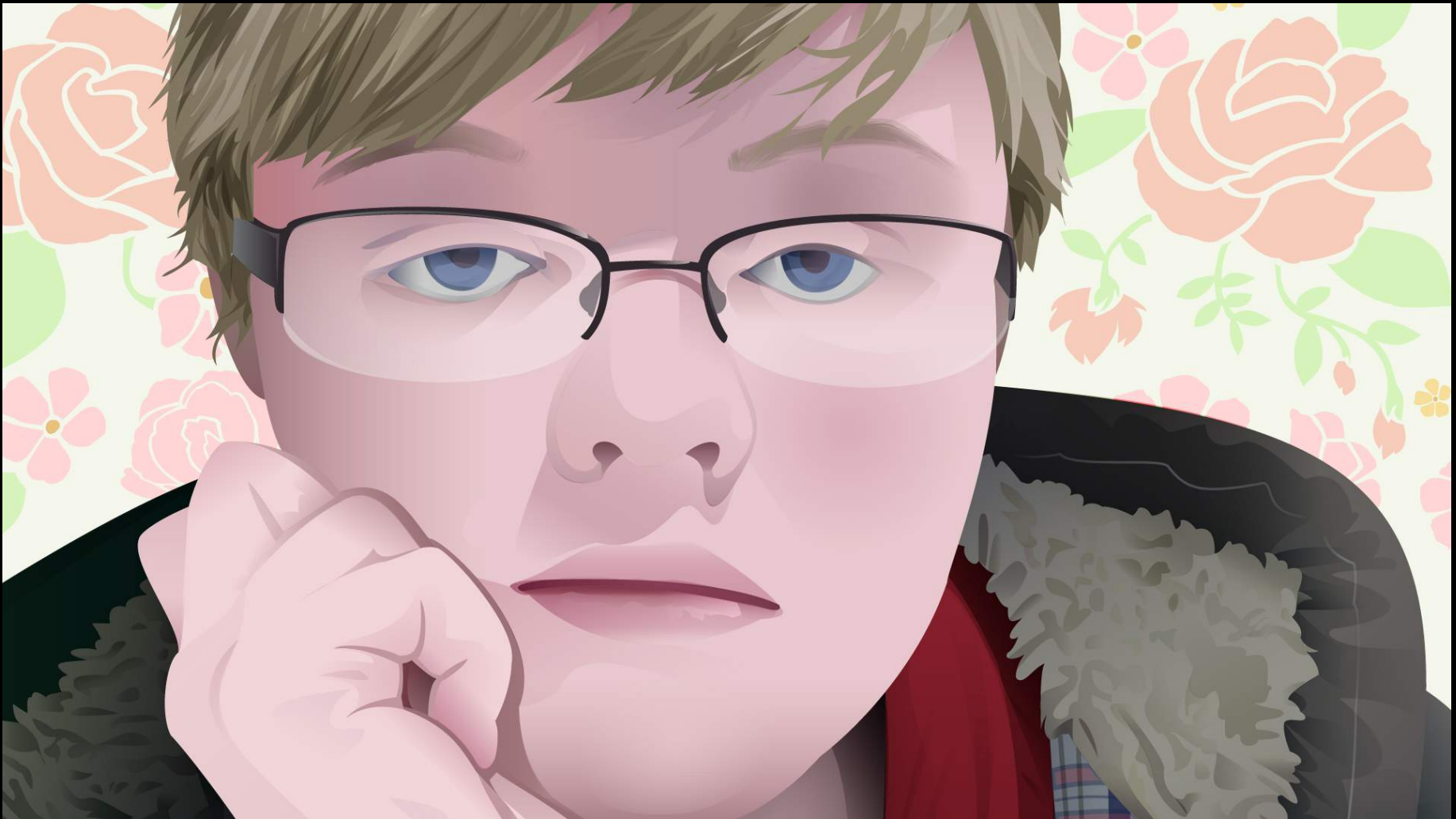

Student name: Kristin Stanton

School name: Southwest Career and Technical Academy

Program: Video Game Development

Faculty name: Maureen Clark

Project: Self Portrait Close Up





Student name: Kristin Stanton

School name: Southwest Career and Technical Academy

Program: Video Game Development

Faculty name: Maureen Clark

Project: Self Portrait



Student name: Emerald Liu

School name: Southwest Career and Technical Academy

Program: Web Design and Development

Faculty name: Maureen Clark

Project: Self Portrait Close Up





Student name: Emerald Liu

School name: Southwest Career and Technical Academy

Program: Web Design and Development

Faculty name: Maureen Clark

Project: Self Portrait





Student name: Danielle Johnson

School name: Southwest Career and Technical Academy

Program: Web Design and Development

Faculty name: Maureen Clark

Project: Self Portrait Close Up





Student name: Danielle Johnson

School name: Southwest Career and Technical Academy

Program: Web Design and Development

Faculty name: Maureen Clark

Project: Self Portrait

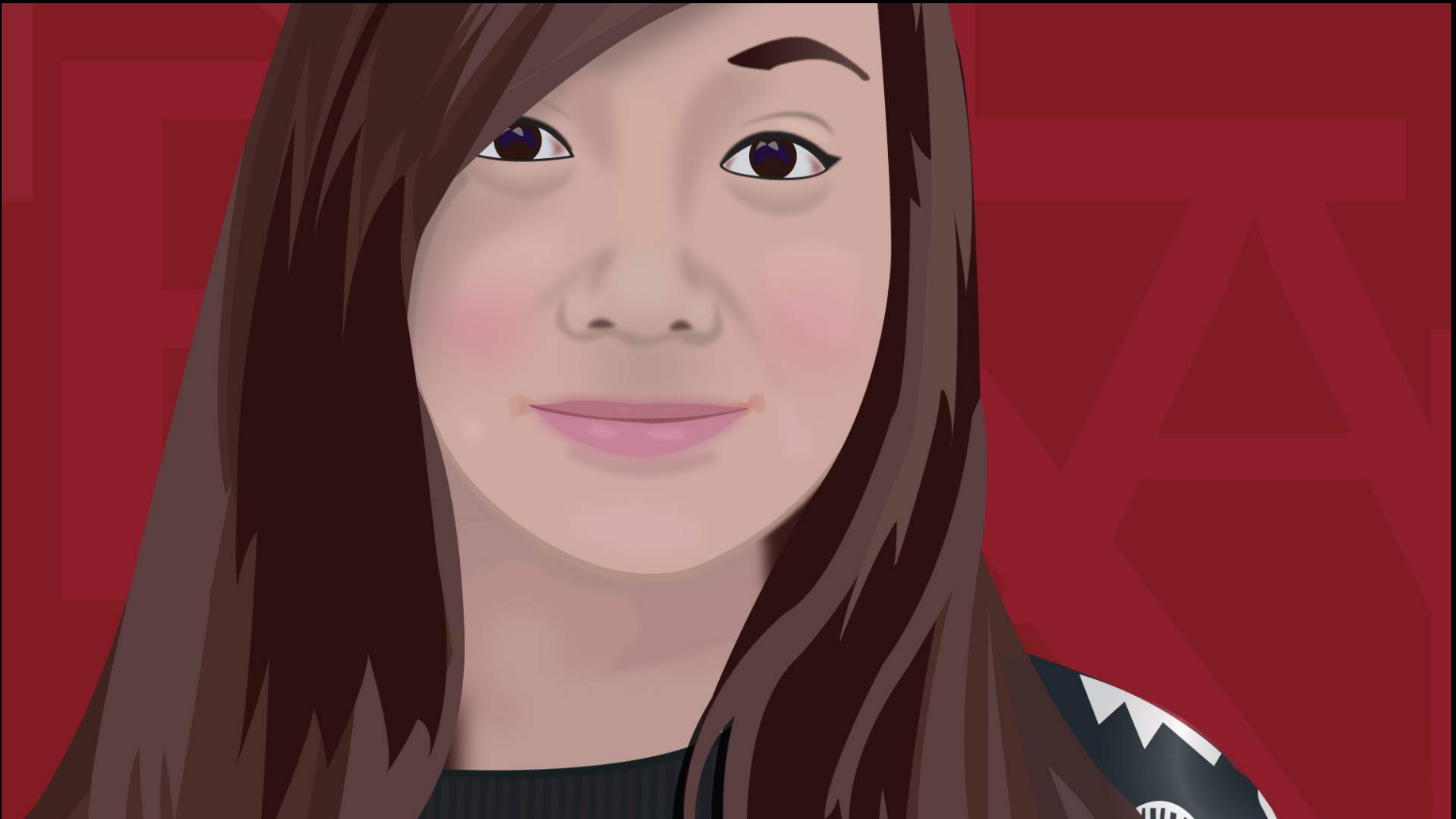

Student name: Kenna Venegas

School name: Southwest Career and Technical Academy

Program: Web Design and Development

Faculty name: Maureen Clark

Project: Self Portrait Close Up





Student name: Kenna Venegas

School name: Southwest Career and Technical Academy

Program: Web Design and Development

Faculty name: Maureen Clark

Project: Self Portrait



Student name: Carlos Hernandez

School name: Southwest Career and Technical Academy

Program: Video Game Development

Faculty name: Maureen Clark

Project: Self Portrait Close Up



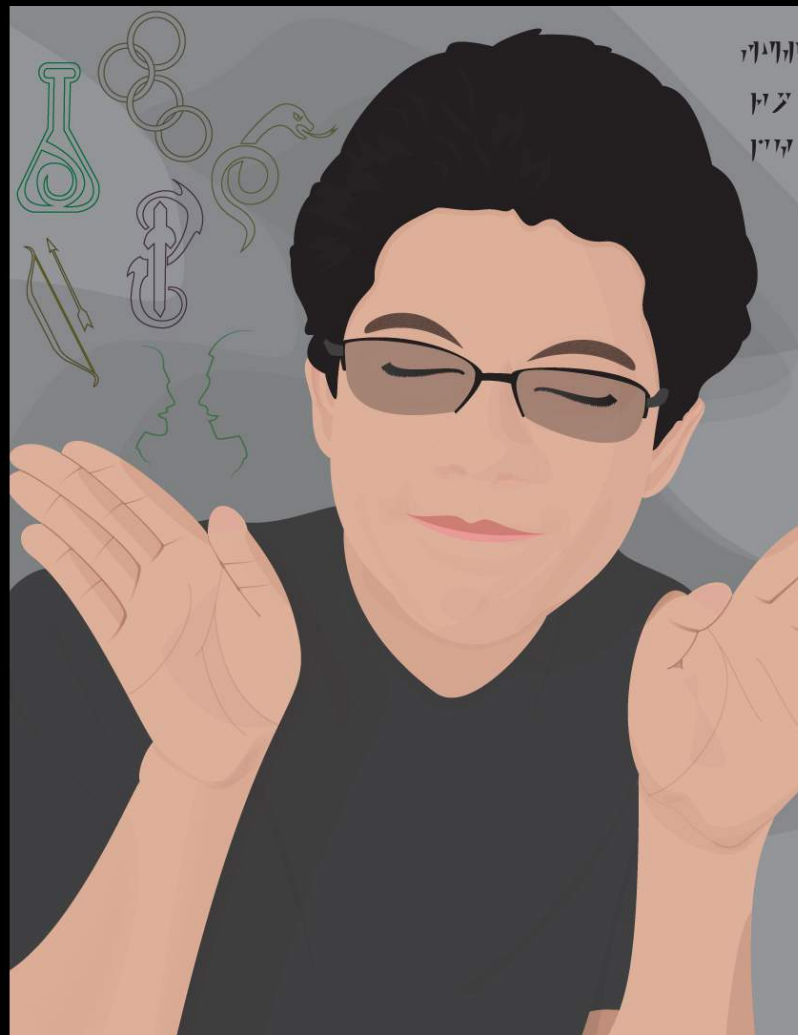

Student name: Carlos Hernandez

School name: Southwest Career and Technical Academy

Program: Video Game Development

Faculty name: Maureen Clark

Project: Self Portrait



Student name: Christian Ramos

School name: Southwest Career and Technical Academy

Program: Video Game Development

Faculty name: Maureen Clark

Project: Self Portrait Close Up





Student name: Christian Ramos

School name: Southwest Career and Technical Academy

Program: Video Game Development

Faculty name: Maureen Clark

Project: Self Portrait



Student name: Melanie Zingle

School name: Southwest Career and Technical Academy

Program: Video Game Development

Faculty name: Maureen Clark

Project: Self Portrait Close Up





Student name: Melanie Zingle

School name: Southwest Career and Technical Academy

Program: Video Game Development

Faculty name: Maureen Clark

Project: Self Portrait





Student name: Skylar Smith

School name: Southwest Career and Technical Academy

Program: Video Game Development

Faculty name: Maureen Clark

Project: Self Portrait Close Up





Student name: Skylar Smith

School name: Southwest Career and Technical Academy

Program: Video Game Development

Faculty name: Maureen Clark

Project: Self Portrait





Student name: Andrea Galvan

School name: Southwest Career and Technical Academy

Program: Web Design and Development

Faculty name: Maureen Clark

Project: ACA Championship Cartoon Illustration

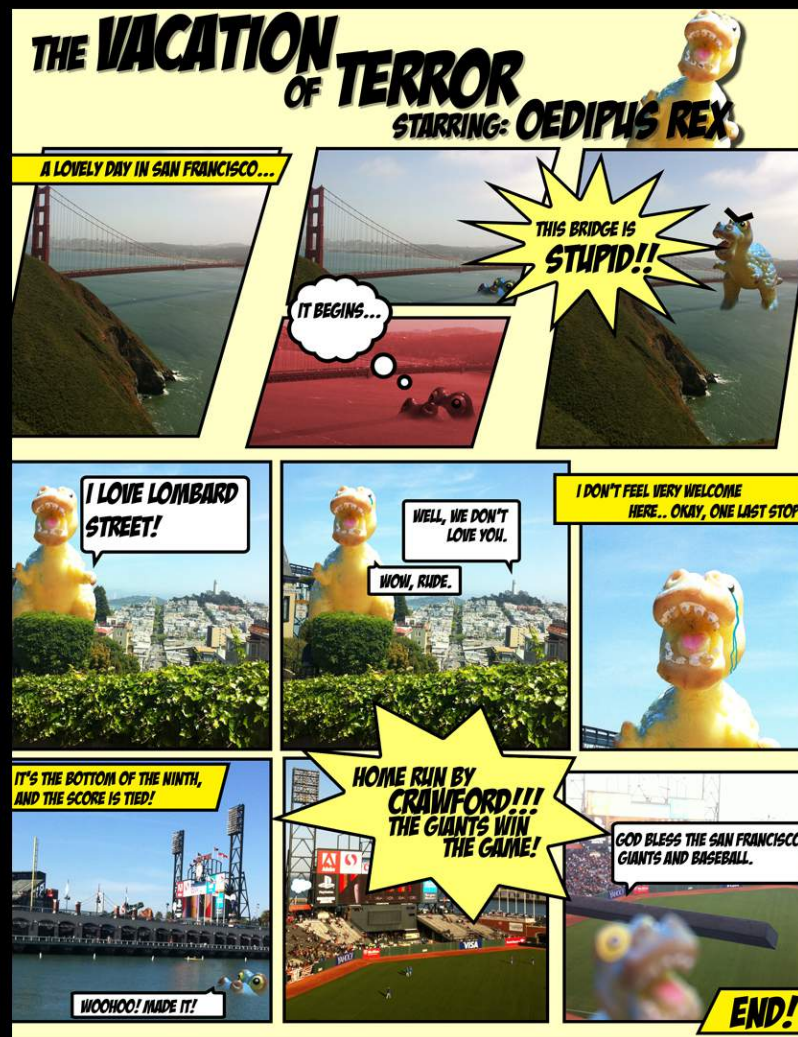

Student name: Andrea Galvan

School name: Southwest Career and Technical Academy

Program: Web Design and Development

Faculty name: Maureen Clark

Project: ACA Championship Cartoon Illustration

THE HERO OF THE WORLDWIDE WEB



Student name: Jonathan Jackson

School name: Southwest Career and Technical Academy

Program: Web Design and Development

Faculty name: Maureen Clark

Project: ACA Championship Cartoon Illustration



Student name: Jonathan Jackson

School name: Southwest Career and Technical Academy

Program: Web Design and Development

Faculty name: Maureen Clark

Project: ACA Championship Cartoon Illustration





Student name: Travis Adenau

School name: Syracuse University

Program/department: Computer Art & Animation/Department of Transmedia

Faculty name: Rebecca Ruige Xu

Project: Character with Attitude (First Year Project)





Student name: Mara Tuccio

School name: Syracuse University

Program/department: Computer Art & Animation/Department of Transmedia

Faculty name: Rebecca Ruige Xu

Project: Character with Attitude (First Year Project)



ACM **SIGGRAPH**
EDUCATION COMMITTEE



Student name: Kevin Wegener

School name: Syracuse University

Program/department: Computer Art & Animation/Department of Transmedia

Faculty name: Rebecca Ruige Xu

Project: Character with Attitude (First Year Project)



ACM **SIGGRAPH**
EDUCATION COMMITTEE



Student name: Travis Adenau

School name: Syracuse University

Program/department: Computer Art & Animation/Department of Transmedia

Faculty name: Rebecca Ruige Xu

Project: Abstract Figure/Portrait (First Year Project)



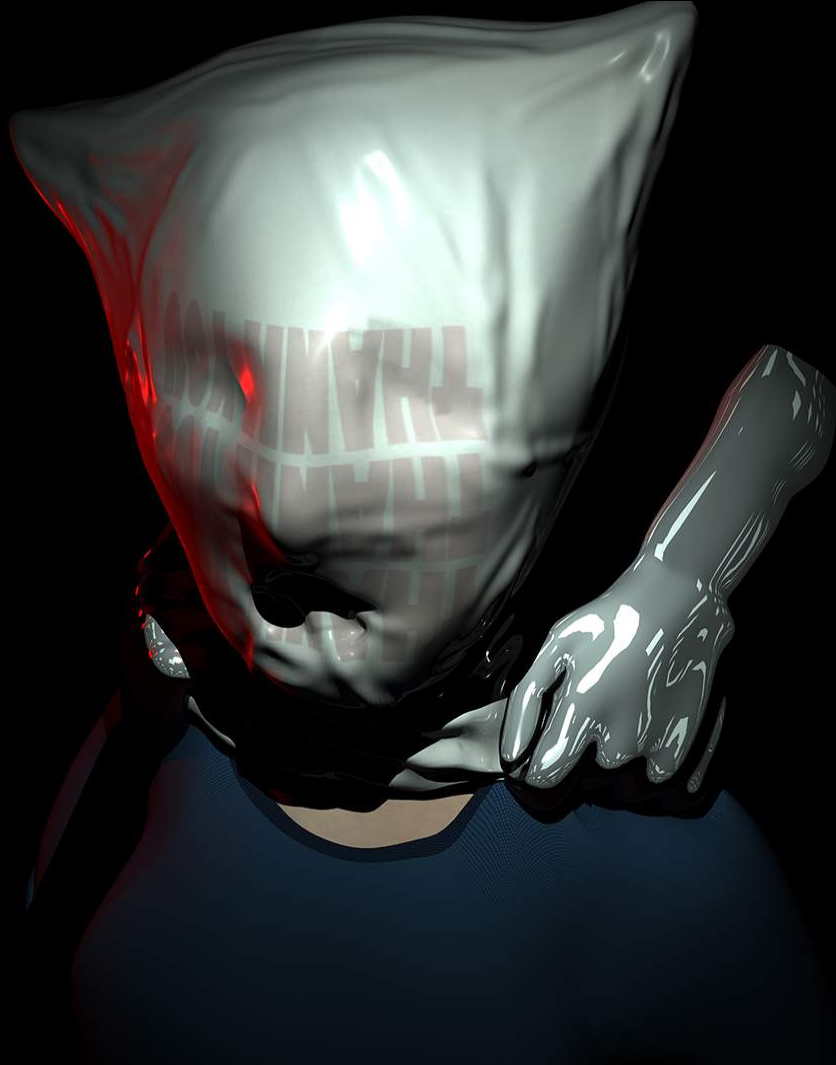

Student name: Natalie Vinciguerra

School name: Syracuse University

Program/department: Computer Art & Animation/Department of Transmedia

Faculty name: Rebecca Ruige Xu

Project: Abstract Figure/Portrait (First Year Project)



ACM **SIGGRAPH**
EDUCATION COMMITTEE

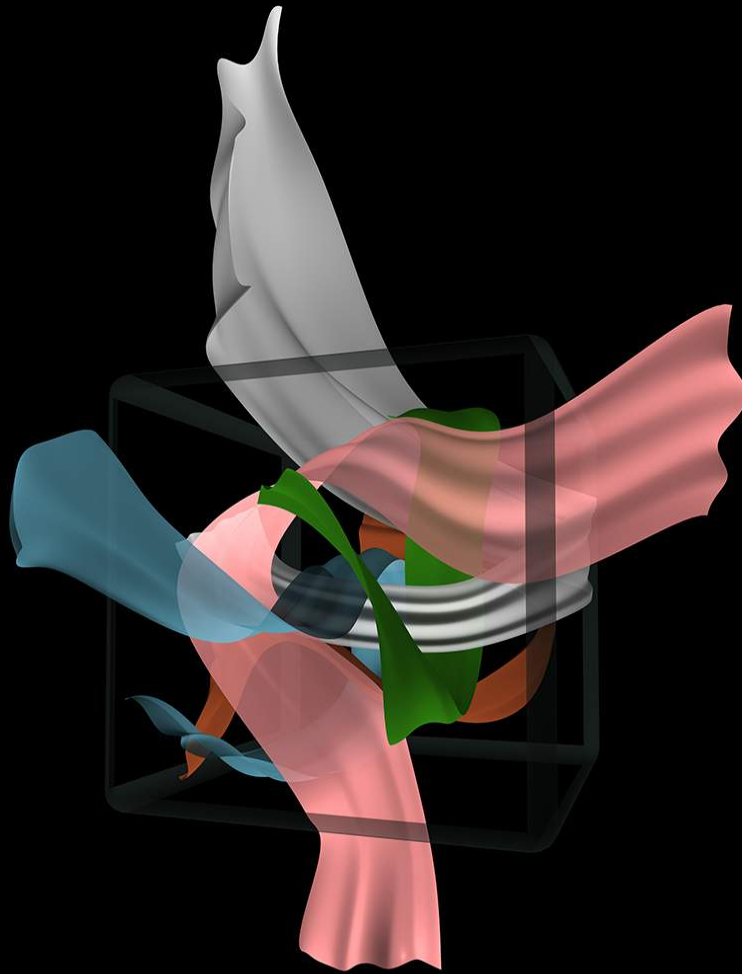

Student name: Jasmine Wu

School name: Syracuse University

Program/department: Computer Art & Animation/Department of Transmedia

Faculty name: Rebecca Ruige Xu

Project: Abstract Figure/Portrait (First Year Project)



ACM **SIGGRAPH**
EDUCATION COMMITTEE



<https://vimeo.com/93399936>

Student name: Daniel Rao

School name: Syracuse University

Program/department: Computer Art & Animation/Department of Transmedia

Faculty name: Rebecca Ruige Xu & Heath Hanlin

Project: Senior Thesis Project



ACM SIGGRAPH
EDUCATION COMMITTEE



<https://vimeo.com/92809687>

Student name: Taolun Guo

School name: Syracuse University

Program/department: Computer Art & Animation

Faculty name: Rebecca Ruige Xu & Heath Hanlin

Project: Senior Thesis Project





<https://vimeo.com/96543343>

Student name: Kristan King

School name: University of Houston-Clear Lake

Program/department: Digital Media Studies Program

Faculty name: Anne Henry

Project: Animated Poem





<https://vimeo.com/96543342>

Student name: Ruba Shaikh

School name: University of Houston-Clear Lake

Program/department: Digital Media Studies Program

Faculty name: Anne Henry

Project: Animated Poem





METROTOWN

Remembering the Places Where I have Lived



<https://vimeo.com/96533502>

Student name: Liana Cadavid

School name: University of Houston-Clear Lake

Program/department: Digital Media Studies Program

Faculty name: Anne Henry

Project: "Scrolling" down Memory Lane





<https://vimeo.com/96533501>

Student name: Brenda Fixel

School name: University of Houston-Clear Lake

Program/department: Digital Media Studies Program

Faculty name: Anne Henry

Project: "Scrolling" down Memory Lane





<https://vimeo.com/96533503>

Student name: F. Jeramie Ibarra

School name: University of Houston-Clear Lake

Program/department: Digital Media Studies Program

Faculty name: Anne Henry

Project: "Scrolling" down Memory Lane





<https://vimeo.com/96531011>

Student name: Amy Nichols

School name: University of Houston-Clear Lake

Program/department: Digital Media Studies Program

Faculty name: Anne Henry

Project: "Scrolling" down Memory Lane



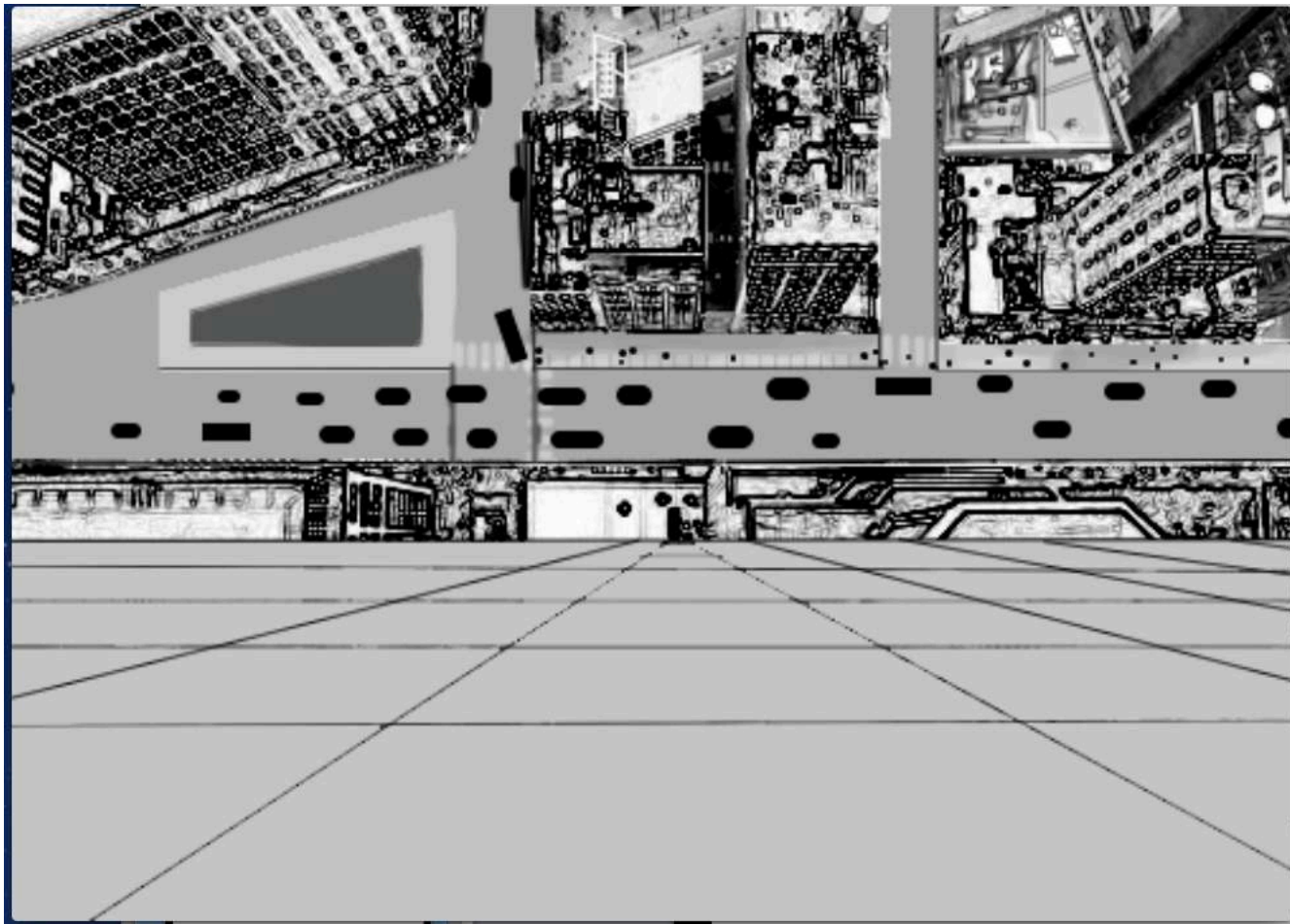

http://ursyn.com/student_gallery/gabe_garcia.html

Student name: Gabe Garcia

School name: University of Northern Colorado

Program/department: Computer Graphics

Faculty name: Dr. Anna Ursyn

Project: Value – Pencil City



Student name: Hanna Rainsford

School name: University of Northern Colorado

Program/department: Computer Graphics

Faculty name: Dr. Anna Ursyn

Project: Value – Pencil City

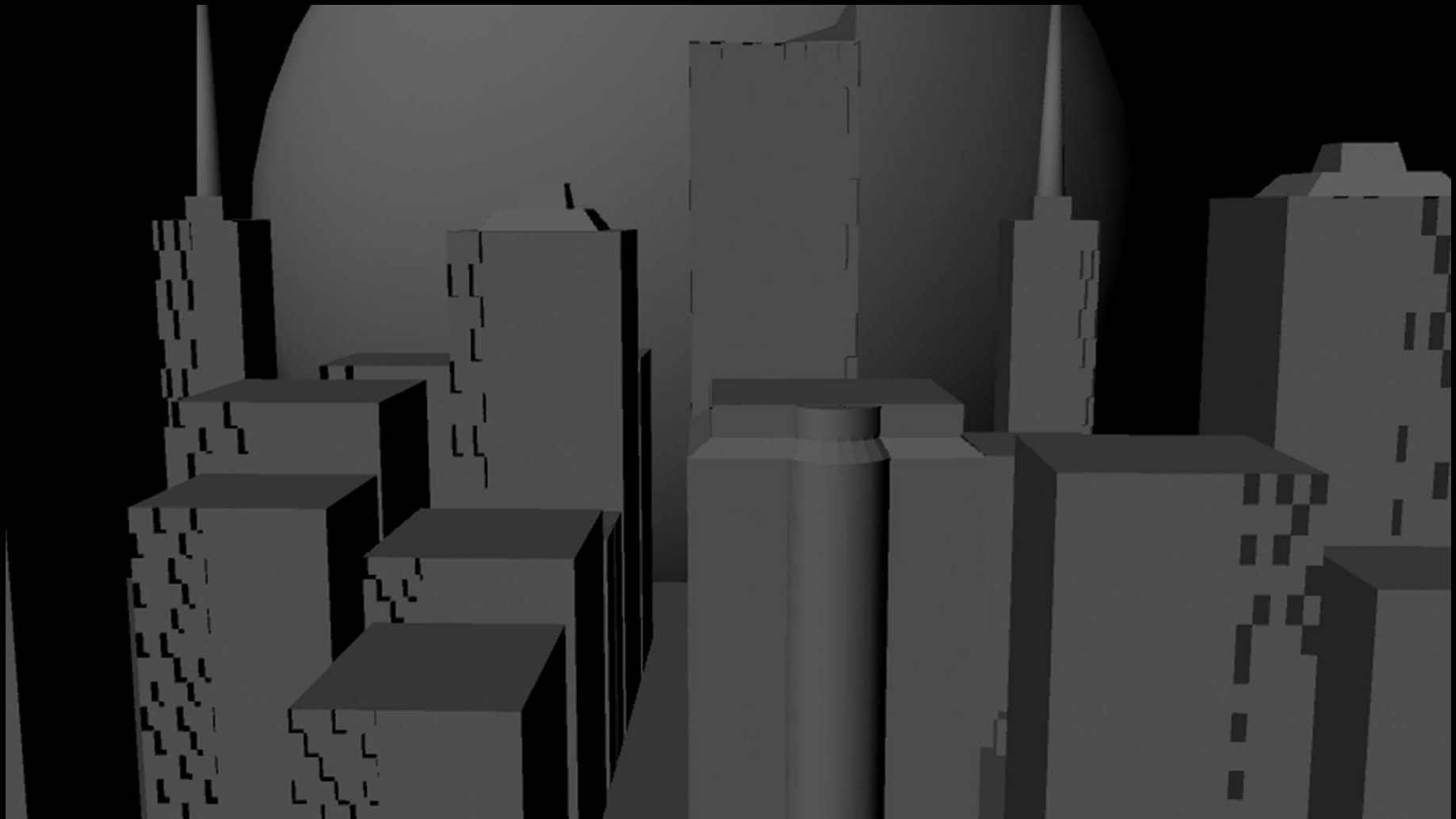

Student name: Jamie Tobin

School name: University of Northern Colorado

Program/department: Computer Graphics

Faculty name: Dr. Anna Ursyn

Project: Value – Pencil City





Student name: Jon Furphy

School name: University of Northern Colorado

Program/department: Computer Graphics

Faculty name: Dr. Anna Ursyn

Project: Value – Pencil City

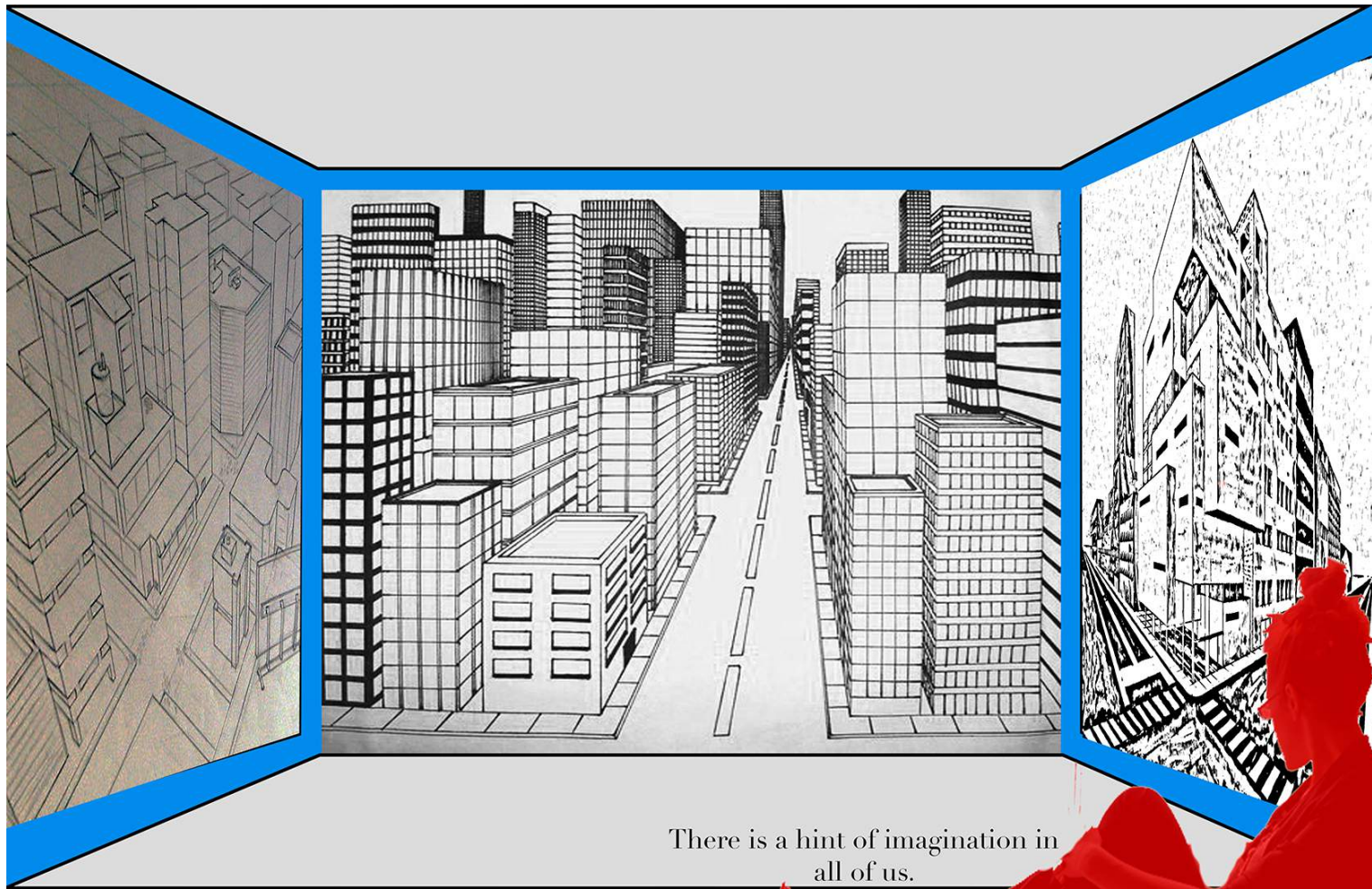

There is a hint of imagination in
all of us.

Student name: Lauren Arline

School name: University of Northern Colorado

Program/department: Computer Graphics

Faculty name: Dr. Anna Ursyn

Project: Value – Pencil City



<https://www.youtube.com/watch?v=2b0hxG4Nv6w&feature=youtu.be>

Student name: Christoph Knorr, Ansgar Maehrlein, Torben Niklas Meyer, Timo Renzelmann, Georg Stilow, Christian Stroehmeier

School name: University of Paderborn, Germany

Program/department: Real-Time Rendering/Dept. of Science



Faculty name: Gitta Domik

Project: Shader Programming (GLSL) of RT effects - Bachelor Projects



http://youtu.be/cb-7_69bXCk

Student name: Oliver Schwede, Christian Klaussner & Sascha Holl

School name: University of Paderborn, Germany

Program/department: Real-Time Rendering/Dept. of Science



Faculty name: Gitta Domik

Project: Shader Programming (GLSL) of RT effects – Masters Projects



<http://youtu.be/cAXVrCBax3Q>

Student name: Peter Wagener & Stanislaw Eppinger

School name: University of Paderborn, Germany

Program/department: Real-Time Rendering/Dept. of Science

Faculty name: Gitta Domik

Project: Shader Programming (GLSL) of RT effects – Masters Projects





<http://youtu.be/WHUiU2lfZww>

Student name: Jan-Hendrick Bock, Henrik Heine & Marcel Landwehr

School name: University of Paderborn, Germany

Program/department: Real-Time Rendering/Dept. of Science

Faculty name: Gitta Domik

Project: Shader Programming (GLSL) of RT effects – Masters Projects





http://youtu.be/27N8BP_TkkQ

Student name: David Brenken, Christoph Ruething & Tim Niklas Vinkemeier

School name: University of Paderborn, Germany

Program/department: Real-Time Rendering/Dept. of Science

Faculty name: Gitta Domik

Project: Shader Programming (GLSL) of RT effects – Masters Projects





<http://youtu.be/G9JuL43YnQs>

Student name: Felix Pauck, Dieter Dima Enns & Christopher Skerra

School name: University of Paderborn, Germany

Program/department: Real-Time Rendering/Dept. of Science



Faculty name: Gitta Domik

Project: Shader Programming (GLSL) of RT effects – Masters Projects

Maya Plugin Authoring Tool: Illuminati

Beiling Lu & Zihao Feng

Based on SigGraph Paper: A Programmable System for Artistic Volumetric Lighting,

by Derek Nowrouzezahrai, Jared Johnson, Andrew Selle, Dylan Lacewell, M. Kaschalk, Wojciech Jaroz, 2011

OUTPUT



Physically-accurate shader

<https://www.youtube.com/watch?v=ZnRKMBolR4I&feature=youtu.be>

Student name: Advanced Computer Graphics and Animation (CIS660)

School name: University of Pennsylvania

Program/department: Computer Graphics and Game Technology
Computer & Info Science Dept.

Faculty name: Prof. Stephen H. Lane

Project: Maya Plugin Authoring Tool Projects



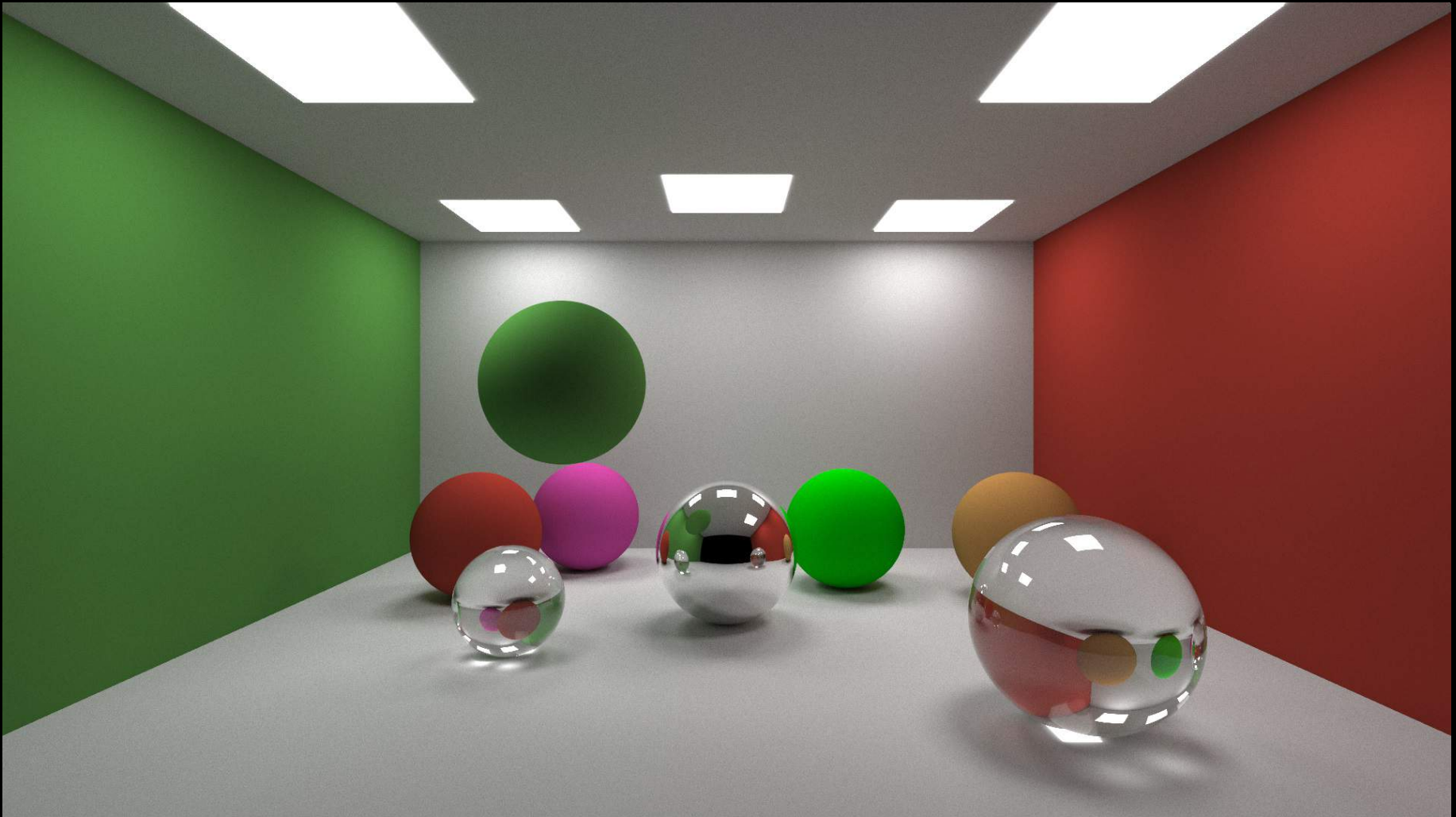

Student name: Hao Wu

School name: University of Pennsylvania

Program/department: Computer Graphics and Game Technology

Faculty name: Patrick Cozzi

Project: GPU-Accelerated Path Tracer



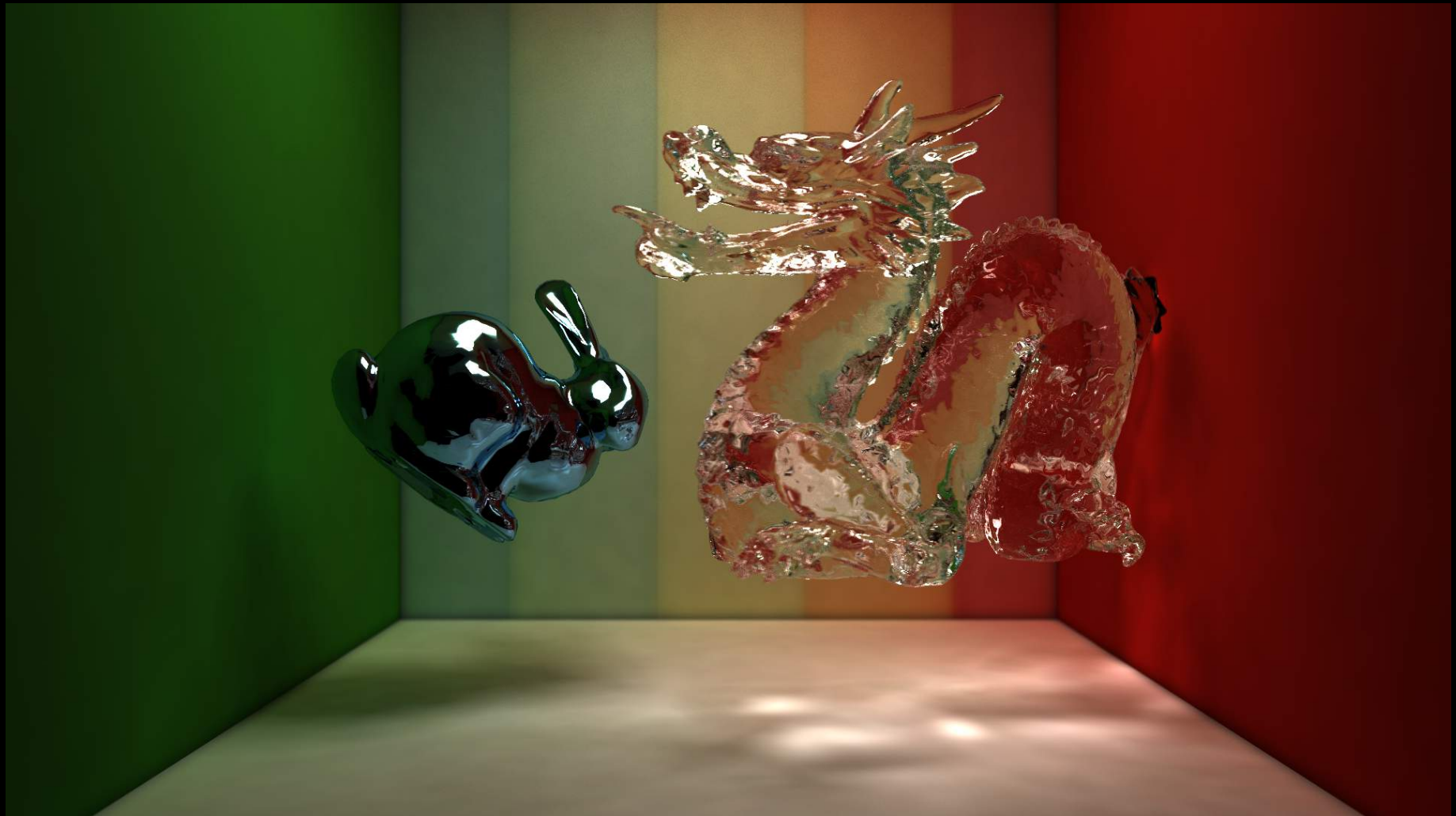

Student name: Ishaan Singh, Yingting Xiao, and Xiaoyan Zhu

School name: University of Pennsylvania

Program/department: Computer Graphics and Game Technology

Faculty name: Patrick Cozzi

Project: GPU-Accelerated Photon Mapper





<http://vimeo.com/97049866>

Student name: Christina DellOsso

School name: William Paterson University

Program/department: Department of Art

Faculty name: Steve Rittler

Project: Senior Thesis Project





<https://vimeo.com/97158210>

Student name: Talon Tarkenton

School name: Woodbury University

Program/department: Animation Department

Faculty name: Ric Heitzman

Project: Dinosaur Story





<https://vimeo.com/97157834>

Student name: Richard Ramos

School name: Woodbury University

Program/department: Animation Department

Faculty name: Ric Heitzman

Project: Missing Links





<https://vimeo.com/97156592>

Student name: Andrew Bendik, Nicole Rola & Ryan Tengel

School name: Woodbury University

Program/department: Animation Department

Faculty name: Ric Heitzman

Project: Stubbs





ACM SIGGRAPH
EDUCATION COMMITTEE

**2014 FACULTY SUBMITTED
STUDENT WORK EXHIBIT**